

EmbryoScope™ 8 incubator

User manual



Table of contents

1	Introduction	5
1.1	Warnings, restrictions and limited warranty	6
1.2	Intended use	10
1.3	Intended users	10
1.4	Clinical benefits	11
1.5	Proposed workarounds	11
2	Overview of the EmbryoScope 8 incubator	12
2.1	Overview of features in the EmbryoScope 8 incubator	13
2.1.1	Barcode labelling system	15
2.2	Installation and required conditions	16
2.2.1	Transportation and relocation of the EmbryoScope 8 incubator	17
2.3	Starting up the EmbryoScope 8 incubator	18
2.4	Shutting down the EmbryoScope 8 incubator and removing all culture dishes	18
2.5	Restarting the integrated PC	19
3	Connections to supporting systems	20
3.1	Gas	22
3.2	ES server	23
3.3	External alarm output	24
3.4	Incubator data	24
3.5	USB connections	24
4	Operating the EmbryoScope 8 incubator	25
4.1	The incubator screen	25
4.1.1	Navigating on the incubator screen	26
4.1.2	Change set point mode	27
4.1.3	Validation and calibration mode	29
4.1.4	Controlling the incubator temperature	32
4.1.4.1	Changing the temperature set point	32
4.1.4.2	Calibrating the temperature	33
4.1.5	Controlling the CO ₂ /O ₂ concentration	36
4.1.5.1	Changing the CO ₂ /O ₂ set point	36
4.1.5.2	Validating the CO ₂ /O ₂ concentration	38
4.1.5.3	Calibrating the CO ₂ /O ₂ concentration	41
4.1.6	Incubator O ₂ regulation	43

4.1.6.1	Turning on/off the O ₂ regulation	43
4.2	The PC screen	44
4.2.1	PC home screen	44
4.2.1.1	Colours on the home screen	44
4.2.1.2	Starting a culture dish	46
4.2.1.3	Barcode errors	50
4.2.1.4	Removing a single culture dish	52
4.2.1.5	Removing all culture dishes	52
4.2.1.6	Resuming culture in a culture dish	53
4.2.2	Culture dish overview screen	55
4.2.2.1	Disabling image acquisition for individual wells	57
4.2.3	Settings screen	58
4.2.3.1	Enabling and disabling the screen saver	59
5	Cleaning and disinfecting the EmbryoScope 8 incubator	60
5.1	Periodic cleaning of the EmbryoScope 8 incubator	60
5.2	Disinfection of the EmbryoScope 8 incubator	63
6	Changing the VOC HEPA filter	66
7	Replacing the main fuses	72
8	Alarms, warnings and notifications	74
8.1	Types of alarms, warnings and notifications	74
8.1.1	Alarms	74
8.1.2	Warnings	75
8.1.3	Notifications	75
8.2	Temporarily pausing alarms	76
8.3	Overview of the display colours of alarms, warnings and notifications	77
8.3.1	Alarms	77
8.3.2	Warnings	77
8.3.3	Notifications	78
8.4	Multiple simultaneous alarms	78
8.5	Resetting alarms	79
8.6	Graphical overview of alarms and operator response	80
8.7	Graphical overview of warnings and operator response	83
8.8	Graphical overview of notifications and operator response	85
8.9	Overview of error conditions and control unit responses	86

8.10 External alarm system.....	87
8.10.1 Overview of errors sent to the external alarm system	87
8.10.2 Delay of external alarms and warnings	88
8.10.3 Connecting the external alarm	88
9 Emergency procedure	89
9.1 Removing culture dishes after a system failure	89
10 Technical specifications.....	91
11 EMC and HF technical review.....	96
11.1 Electromagnetic emissions	96
11.2 Electromagnetic immunity	97
12 Accessories and materials	101
13 Planned service and maintenance.....	102
13.1 Planned service	102
13.2 Planned maintenance	103
13.2.1 Maintenance screen	104
13.2.2 Generating a monthly incubation report	105
13.2.3 VOC HEPA filter and sensor maintenance.....	106
14 Symbols and labels.....	109
14.1 Product information labels.....	109
14.2 Warning labels	110
14.3 Connection labels	111
14.4 Labels on the shipping crate	112
15 Disposal of waste.....	113
16 Contact information	114

CohortView, CulturePro, EmbryoScope, EmbryoSlide, EmbryoViewer, Guided Annotation, iDAScore and KIDScore are trademarks or registered trademarks belonging to the Vitrolife Group.

©2024 Vitrolife A/S. All rights reserved.

1 Introduction

This user manual provides information on how to use the EmbryoScope 8 incubator.

The end user is strongly encouraged to carefully follow the scheme outlined in the section entitled *Planned service and maintenance* to ensure error-free operation of the incubator.

The EmbryoScope 8 incubator is a medical device that must be operated by trained personnel according to the instructions contained in this user manual. Users must be qualified to operate the device and qualified to perform procedures associated with device use in accordance with local qualification standards.

The product fulfils the requirements of the UL 60601-1 edition 1 and IEC 60601-1:2012 standards; class I, type B equivalent. The EmbryoScope 8 incubator is suitable for continuous operation.

- The EmbryoScope 8 incubator and related accessories conform to the requirements of Regulation (EU) 2017/745 on medical devices, classified as class IIa.
- Conforms to ANSI/AAMI ES 60601-1:2005 + A1 + A2.
- Certified to CAN/CSA - C22.2 No. 60601-1:R2013 addendum.

1.1 Warnings, restrictions and limited warranty

Users must agree to read and understand this user manual and observe the safety instructions before operating the incubator.

RESTRICTIONS ON USE

- The EmbryoScope 8 incubator may only be used by persons who have been trained in its use by a person certified by Vitrolife.
- The EmbryoScope 8 incubator may only be used with sterile disposable culture dishes produced and sold by Vitrolife.
- The culture dishes may not be reused.
- The culture dishes must be covered with sterile lids before insertion into the EmbryoScope 8 incubator.
- The EmbryoScope 8 incubator may not be used in a wet environment. No fluids other than culture medium and oil and the cleaning agents specified in this user manual may be used in or near the incubator.
- Never cover the vent holes on the back of the incubator in part or in whole as this may cause the incubator to overheat.
- Users should contact Vitrolife immediately to report any incident and/or injury to a patient, operator or maintenance employee that occurred as a result of operating the EmbryoScope 8 incubator. Any serious incident that has occurred in relation to the incubator should be reported to the competent authority of the Member State in which the user is established.
- Should an accident occur while using the EmbryoScope 8 incubator, stop using the incubator until it has been checked by a person certified by Vitrolife.

WARNING

- The EmbryoScope 8 incubator includes moving parts with safety stops. Do not try to block safety sensors. If the safety sensors are blocked, inserting a finger or a hand into the incubator while it is turned on is dangerous and may cause injury.
- To avoid risk of electric shock, this incubator must only be connected to a mains supply with a protective earth connection.
- Detachable main power supply cords with inadequate ratings should not be used. See section 10 for power supply ratings.
- The incubator must be positioned to allow the operator to turn on/off the main power switch on the back of the incubator.
- Portable and mobile RF communications equipment may affect the EmbryoScope 8 incubator.
- If the incubator is used in a manner not specified by Vitrolife, the protection against hazards provided by the incubator may be impaired.
- The EmbryoScope 8 incubator is not suitable for use in the presence of a flammable anaesthetic mixture with air or with oxygen or nitrous oxide.
- It is the user's responsibility to validate the performance of the EmbryoScope 8 incubator by performing quality control checks on the temperature, CO₂ and O₂* levels every two weeks.
* Only if the clinic incubates with reduced O₂ concentration.
- During initial start-up and after an incubator shutdown, always validate the gas and temperature levels using calibrated, external validation devices as detailed in this user manual. Do NOT rely solely on values displayed on the incubator screen.

INSTALLATION AND SERVICE

- Installation and service of the EmbryoScope 8 incubator may only be carried out by a person certified by Vitrolife. The EmbryoScope 8 incubator must remain at the location where it was installed. If the EmbryoScope 8 incubator is disconnected and/or moved without supervision by a person certified by Vitrolife, the incubator is no longer approved for clinical use and the warranty may be voided.
- If the EmbryoScope 8 incubator or parts of it are modified, appropriate inspection and testing must be conducted by a person certified by Vitrolife to ensure continued safe use.
- When cleaning and disinfecting the EmbryoScope 8 incubator, always use the prescribed chemical agents as specified in section 5 of this user manual.

TRANSPORTATION AND RELOCATION OF THE EMBRYOSCOPE 8 INCUBATOR

- While the EmbryoScope 8 incubator is still in the shipping boxes, it must only be moved by using a lift truck or a pallet lifter. Do NOT open the shipping boxes without the presence of a person certified by Vitrolife.
- When the EmbryoScope 8 incubator has been unpacked, it must only be moved by two persons supporting the incubator in accordance with the instructions contained in this user manual and only under the supervision of a person certified by Vitrolife (see section 2.2.1).

CONNECTION TO EXTERNAL EQUIPMENT

(EN 60601-1 MEDICAL ELECTRICAL EQUIPMENT – PART 1)

- External equipment intended for connection to signal input, signal output or other connectors must comply with the relevant IEC standard (i.e. EN 60601-1:2006 – Part 1 for medical electrical equipment). In addition, all such combinations – systems – must comply with the standard EN 60601-1:2015 – Part 2, General requirements for basic safety and essential performance. Equipment not complying with EN 60601-1:2006 – Part 1 must be kept outside the patient environment, i.e. at least 1.5 m from the patient or the patient support.
- Any person who connects external equipment to signal input, signal output or other connectors has formed a system and is therefore responsible for ensuring that the system complies with the requirements of EN 60601-1:2006 – Part 1. If in doubt, contact a qualified medical technician or your local representative.

ELECTROMAGNETIC COMPATIBILITY

- The EmbryoScope 8 incubator has been tested and found to comply with the limits for medical devices set out in the IEC 60601-1-2 Edition 4.0 for electromagnetic compatibility. These limits are designed to provide reasonable protection against harmful interference in a typical medical installation.

Compliance with IEC 60601-1-2 Edition 4.0 ensures compatibility when the EmbryoScope 8 incubator is placed at a minimum distance to nearby instruments. If the EmbryoScope 8 incubator is placed close to other instruments, it is necessary to observe that the performance of all instruments remains unaffected by the placement.

The EmbryoScope 8 incubator generates, uses and can radiate radio frequency energy and, if not installed and used in accordance with the instructions, may cause harmful interference to other instruments in the vicinity. However, there is no guarantee that interference will not occur in a particular installation. If this incubator does cause harmful interference to other instruments, which can be determined by turning the incubator off and on, the user is encouraged to try to correct the interference by one or more of the following measures:

- a) Reorient or relocate the receiving instrument;
- b) Increase the separation between the instruments;
- c) Connect the incubator to an outlet on a circuit different from that to which the other instrument(s) are connected.

Consult the manufacturer, its representative or its dealer for help.

WARNING

- The use of accessories, transducers and cables other than those specified, with the exemption of transducers and cables sold by the manufacturer of the system as replacement parts for internal components, may result in increased emissions or decreased immunity of the equipment or system.
- The EmbryoScope 8 incubator should not be used adjacent to or stacked with other equipment. If adjacent or stacked use is necessary, the incubator should be observed to verify normal operation in the configuration in which it will be used.

CONFIDENTIALITY

- All identification numbers, names and treatment data presented in this manual are fictional.

LIMITED WARRANTY

- Vitrolife warrants the EmbryoScope 8 incubator to be free from defects in materials and workmanship for a period of one (1) year from the first installation date.

The limited warranty will terminate immediately if installation, service, repair or relocation of the incubator is carried out by other than Vitrolife-certified personnel.

The limited warranty does not apply to damage resulting from:

- a) failure to perform routine maintenance in accordance with this user manual;
- b) accident, abuse, misuse or misapplication of the incubator;
- c) use and operation that does not comply with instructions provided in this user manual; or
- d) normal wear and tear.

GENERAL CYBER SECURITY RECOMMENDATIONS

- Users are advised and expected to take the following measures to reduce cyber security risk in order to ensure that the device will work as designed in the intended user environment:
 - Ensure that personnel are properly trained in cyber security awareness
 - Prevent physical access to the equipment by unauthorised users.
- Users must inform Vitrolife A/S without any undue delay upon becoming aware of a cyber security vulnerability incident or any suspected security events.
- For details about how to reduce cyber security risk, please refer to the separate guide on this subject provided by Vitrolife.

1.2 Intended use

The intended use of the EmbryoScope 8 incubator is to provide an environment with controlled temperature and gas concentrations (CO₂ and optionally O₂) for the culture of gametes and/or embryos and to acquire images of these during incubation.

1.3 Intended users

Embryologists, other laboratory personnel and clinic staff at IVF clinics trained by Vitrolife A/S-certified instructors.

1.4 Clinical benefits

- Improved embryo development
- Improved implantation/pregnancy rate
- Reduced pregnancy loss rate.

1.5 Proposed workarounds

For details about any known anomalies and limitations in the software as well as proposed workarounds, refer to the separate handout on this subject provided by Vitrolife.

2 Overview of the EmbryoScope 8 incubator

The EmbryoScope 8 incubator is a tri-gas incubator that acquires a series of unattended measurements on individual embryos during their development. The measurements include: time-lapse microscopy at multiple focal planes and logging of incubation conditions. Separate processing units control the incubation environment and data acquisition to ensure safe and reliable operation.

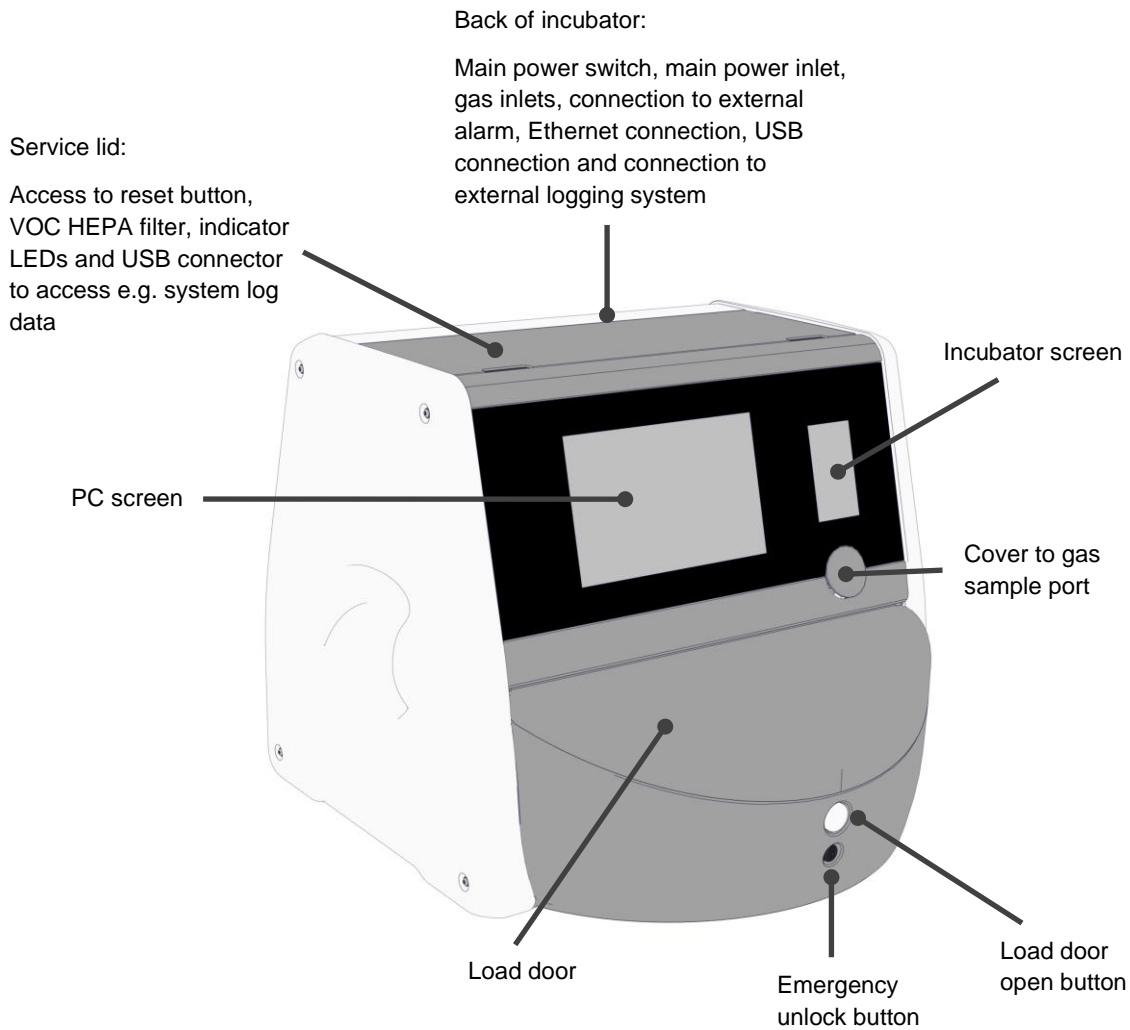

2.1 Overview of features in the EmbryoScope 8 incubator

The EmbryoScope 8 incubator comprises two separate systems: a computer and microscopy system that controls the image acquisition and a gas and temperature system that controls the incubation conditions.

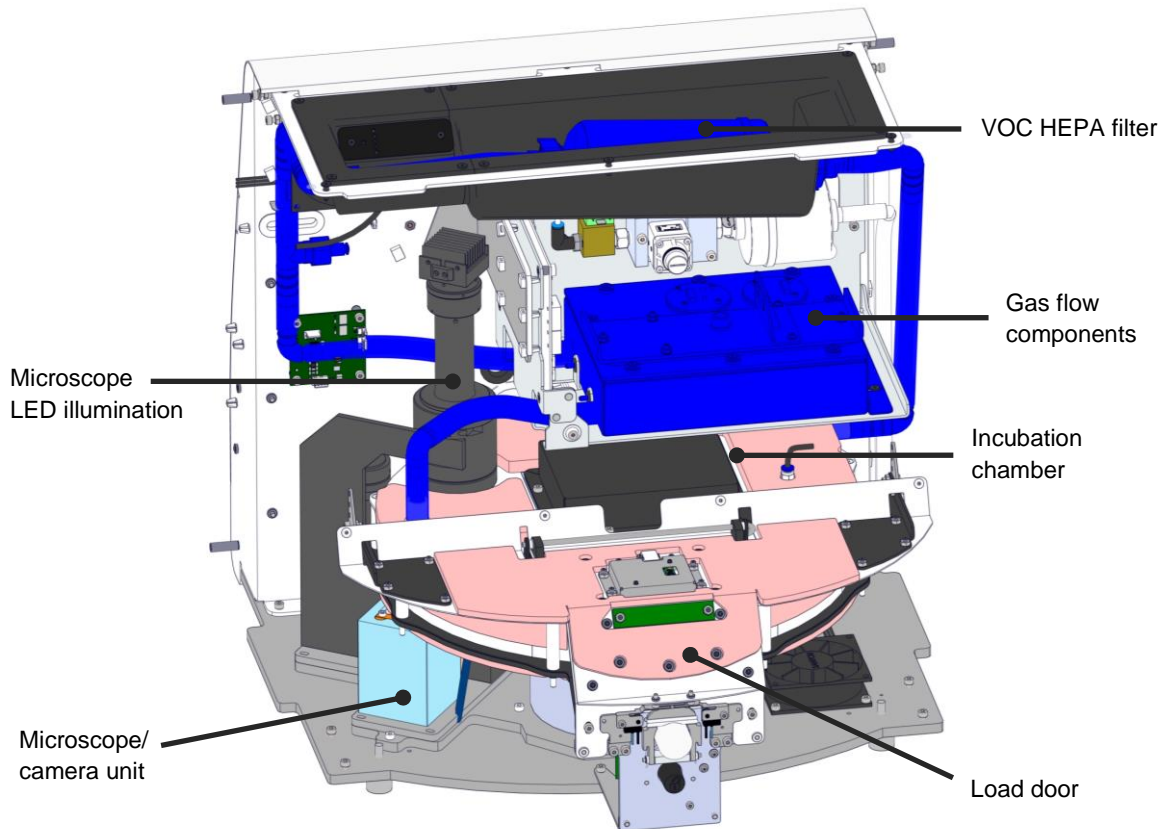

The blue components in the above illustration represent the gas and temperature system of the incubator. These components maintain the desired gas concentrations inside the incubation chamber. The gas is circulated through a VOC HEPA filter before entering the incubation chamber. The same system also controls the temperature conditions inside the incubation chamber.

The embryos that are incubated reside in the culture dish inside the incubation chamber. The culture dish holder in the incubation chamber is disc-shaped and has a maximum capacity of 8 culture dishes.

The built-in microscope is a separate unit placed outside the incubation chamber. The microscope consists of an LED illumination unit and a microscope/camera unit. The set-up corresponds to an ordinary inverted microscope, i.e. with illumination from above and observation through an objective placed beneath the examined embryos.

During image acquisition, each culture dish located on the culture dish holder is rotated to the microscopy system, and individual image stacks are acquired from all individual embryos in each culture dish. During the process, all embryos remain in an undisturbed incubation environment.

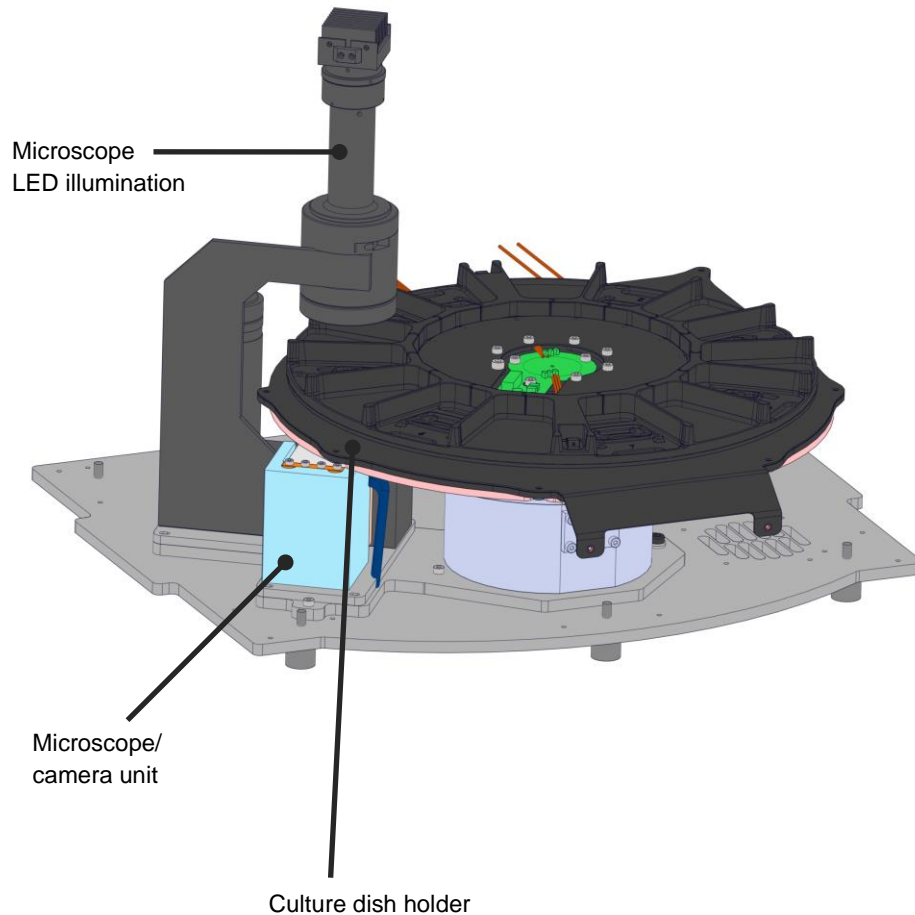

The culture dishes are placed on the culture dish holder in the EmbryoScope 8 incubator. The culture dish holder is a sandwich construction controlled by a thermostat. The holder provides direct heat transfer to the culture dishes and automatically moves the culture dishes from load position to camera position during time-lapse imaging.

The incubation conditions inside the incubation chamber are unaffected by load door openings. The removable frame surrounding the culture dish in load position combined with the fixed partitions between the culture dishes shield the dishes contained within the incubator from outside atmospheric conditions.

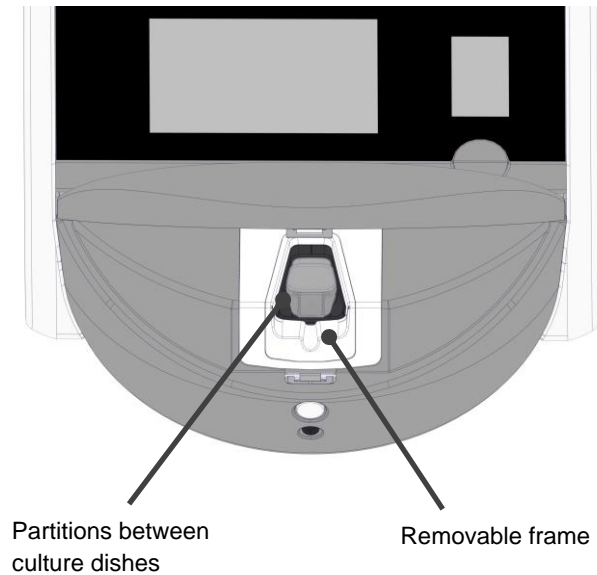

2.1.1 Barcode labelling system

In order to use barcode labels, the operator must print them from the EmbryoViewer and attach them to the designated area on the culture dish (see the user manual for the culture dishes).

The information contained in the barcode is displayed in the **Identification** area of the PC screen when a new culture dish has been inserted:



2.2 Installation and required conditions

The incubator must be set up in accordance with the installation checklist. It should not be moved or disconnected by persons who are not certified by Vitrolife (see section 2.2.1 for information on how to move the incubator).

Installation requirements:

- Clean room with a stable temperature between 20°C and 28°C.
- Sturdy table. The footprint of the device is approx. 0.6 m x 0.6 m. The lab bench space required equals the size of the footprint with the addition of at least 22.5 cm on each side of the device to allow maintenance operations to be performed. A minimum distance of 22.5 cm is also required between the EmbryoScope 8 incubator and other devices placed on the same bench.
- Attachment plug provided with grounding pole and fulfilling local requirements.
- CO₂ gas supply with pressure regulator capable of providing stable output of CO₂ between 0.6 bar - 1 bar above ambient.
- N₂ gas supply with pressure regulator capable of providing stable output of N₂ between 0.6 bar - 1 bar above ambient (only required if the clinic wants to incubate with reduced O₂ concentration).
- Medical electrical equipment requires special precautions regarding EMC and must be installed and put into service according to the EMC information provided.

NOTE

- No cooling facilities are implemented in the incubation chamber. The incubation temperature will always be higher than the ambient temperature. If the temperature rises above the specified limits, the temperature inside the incubation chamber may exceed the set point.
- It is strongly recommended, although not required, to connect the incubator to an uninterruptible power supply (UPS) with earth connector to ensure stable operating conditions in case of power failure. Any UPS connected to the EmbryoScope 8 incubator must comply with the following directives and harmonised standards:
 - Low Voltage Directive 2014/35/EU
 - Electromagnetic Compatibility Directive 2014/30/EU
 - EN 62040-1:2009 Uninterruptible power systems (UPS) – Part 1: General and safety requirements for UPS
 - EN 62040-2:2006 Uninterruptible power systems (UPS) – Part 2: Electromagnetic compatibility (EMC) requirements.

For further details about how to install the incubator, refer to the manual entitled *Planned service and maintenance* (English only).

2.2.1 Transportation and relocation of the EmbryoScope 8 incubator

The EmbryoScope 8 incubator must be moved by two persons positioned on each side of the incubator. Place one hand under the side of the incubator, and place the other hand to support the front of the incubator as illustrated below:

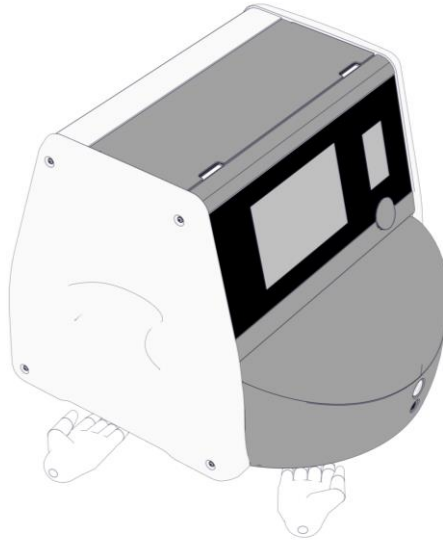

TRANSPORTATION AND RELOCATION OF THE EMBRYOSCOPE 8 INCUBATOR

- While the EmbryoScope 8 incubator is still in the shipping boxes, it must only be moved by using a lift truck or a pallet lifter. Do NOT open the shipping boxes without the presence of a person certified by Vitrolife.
- When the EmbryoScope 8 incubator has been unpacked, it must only be moved by two persons supporting the incubator in accordance with the instructions contained in this user manual and only under the supervision of a person certified by Vitrolife.

2.3 Starting up the EmbryoScope 8 incubator

In order to start up the EmbryoScope 8 incubator (e.g. after service or cleaning), turn on the incubator by pressing the green main power switch on the back of the incubator. The incubator and integrated PC will then automatically start.

After a complete shutdown and during the first installation of the incubator, the EmbryoScope 8 incubator should be turned on at least three hours before use to ensure temperature equilibration throughout the incubator. Ensure that the EmbryoScope 8 incubator is grounded through the power connector, that the gas connections are not leaking, and that the connected gas cylinders are full.

A gas regulator must be used to reduce the pressure in the connected CO₂ and N₂ gas tubes to a level between 0.6 bar and 1.0 bar above ambient pressure.

2.4 Shutting down the EmbryoScope 8 incubator and removing all culture dishes

NOTE
<ul style="list-style-type: none">In case of an emergency, follow the procedure described in section 9.

In order to shut down the EmbryoScope 8 incubator and remove all culture dishes (e.g. for service or cleaning), follow the procedure described below.

1. On the PC home screen, press the settings icon and select **Shutdown**.
2. Select **Remove all culture dishes and shut down** and press **OK**. The first culture dish is moved to the load door, which is unlocked.
3. Open the load door and remove the available culture dish.
4. Close the load door and confirm that you have removed the culture dish.
5. Continue until you have removed all culture dishes from the incubator.
6. Select **Shut down computer**.
7. In order to turn off the incubator completely, use the main power switch located at the back.

2.5 Restarting the integrated PC

In case an irrecoverable error occurs, an error message is displayed on the screen and the integrated PC will automatically restart when you press **OK**.

To manually restart the PC:

1. Open the lid at the top of the incubator.
2. Use a pointed object such as a pencil or a ballpoint pen to press the small red button available under the service lid:

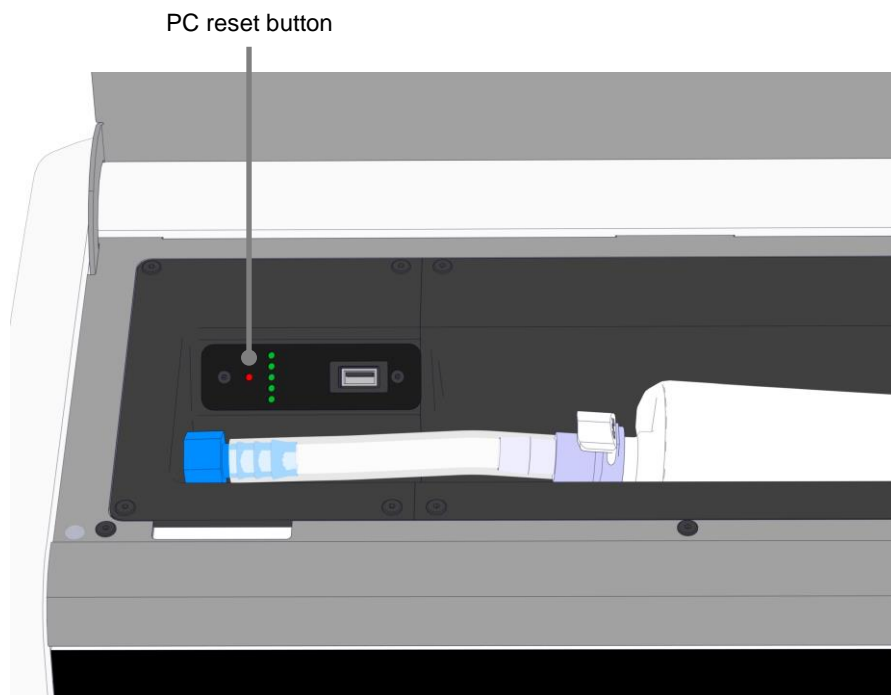

The PC will now shut down.

3. Press the small red button again to restart the PC.

3 Connections to supporting systems

A number of connectors and sockets are found at the back of the EmbryoScope 8 incubator. They should only be used by persons certified by Vitrolife for establishing the relevant connections during installation. Operators should never use or attach any tubing/wiring to the incubator without supervision.

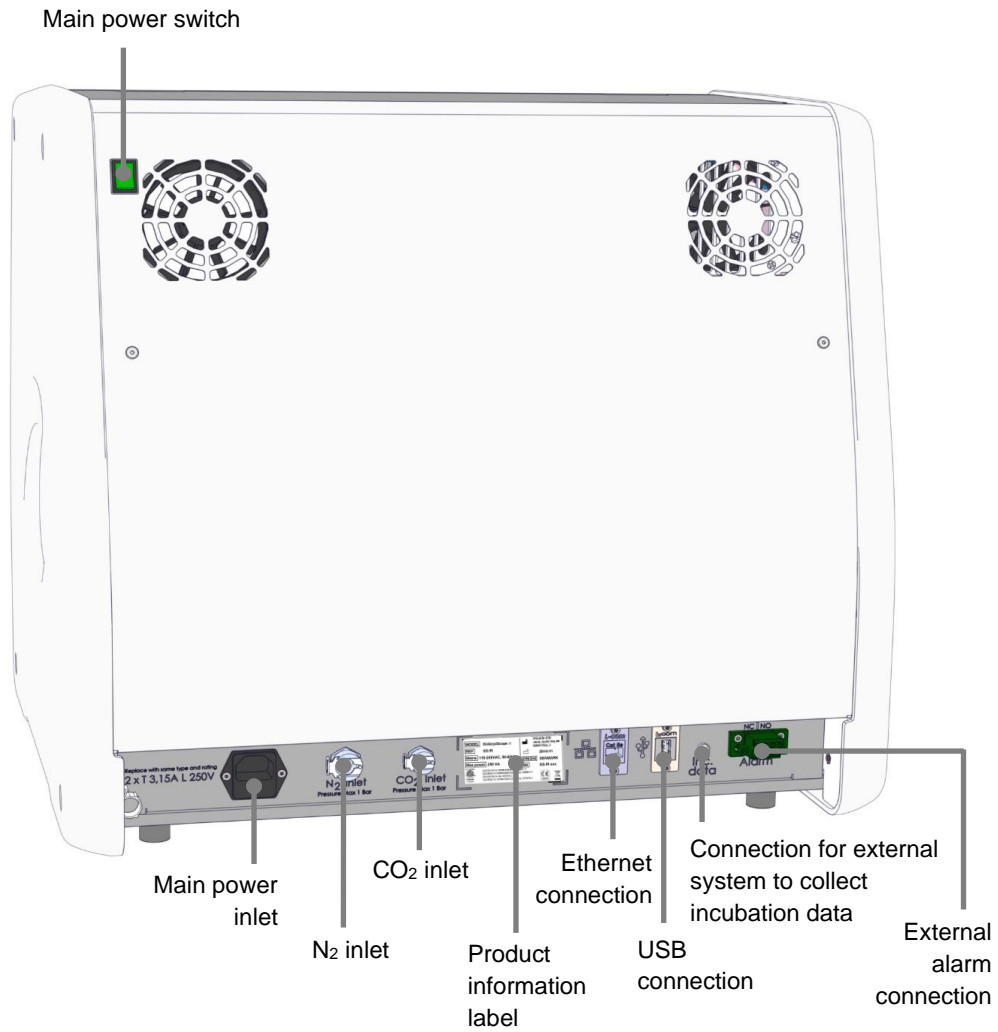

In addition, a USB port that can be used by the clinic to extract monthly incubation reports is available under the service lid at the top of the incubator:

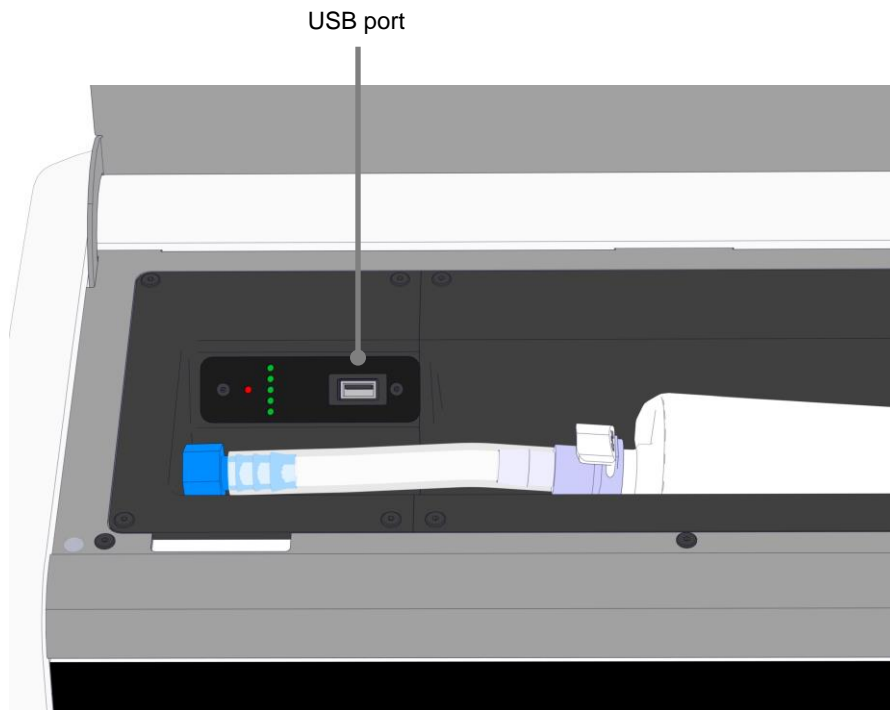

3.1 Gas

CO₂ and N₂ supplies must be attached and secured through the appropriate and labelled inlets by a person certified by Vitrolife.

The gas connector hoses are equipped with quick couplings that prevent the CO₂ hose from being connected to the N₂ inlet and vice versa. The couplings are equipped with an automatic shut-off valve that is activated when the couplings are removed from the inlet on the back of the EmbryoScope 8 incubator.

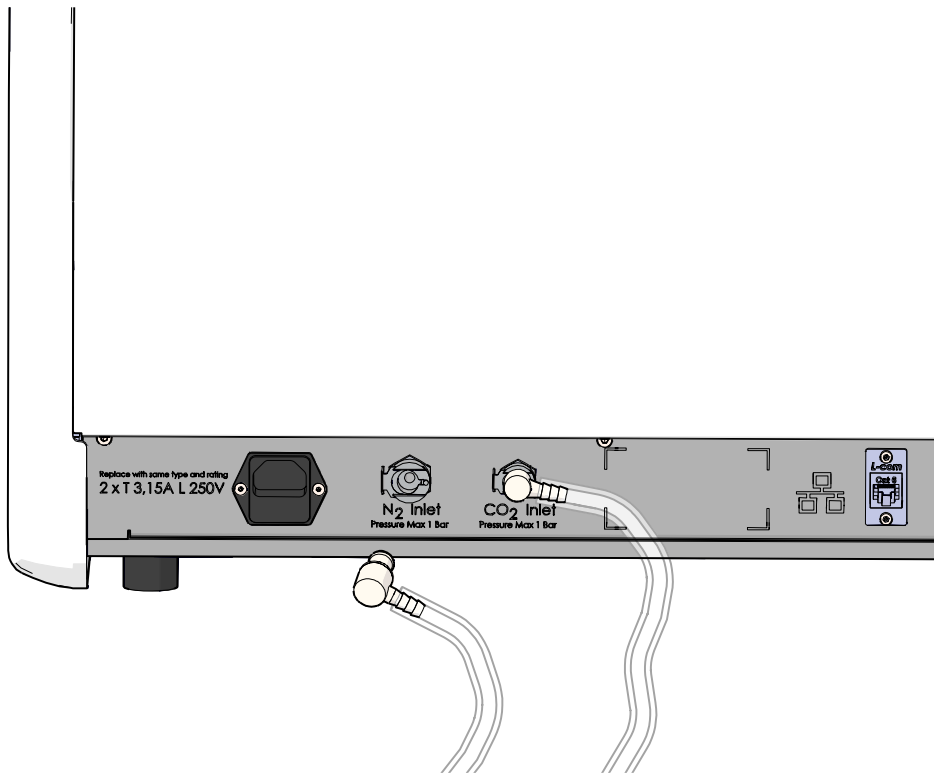

NOTE

- Two internal HEPA filter cartridges protect the sensitive valves and regulator inside the EmbryoScope 8 incubator from any particles in the airstream.

3.2 ES server

The EmbryoScope 8 incubator must be connected to an ES server. The connection is established by Ethernet cable and requires a special set-up, which must be performed by a person certified by Vitrolife. The incubator may not be connected directly to an internet gateway/ISP.

If the connection to the server is lost, press the settings icon  to open the **Settings** screen. Then press the red frame under **Server Connection**.

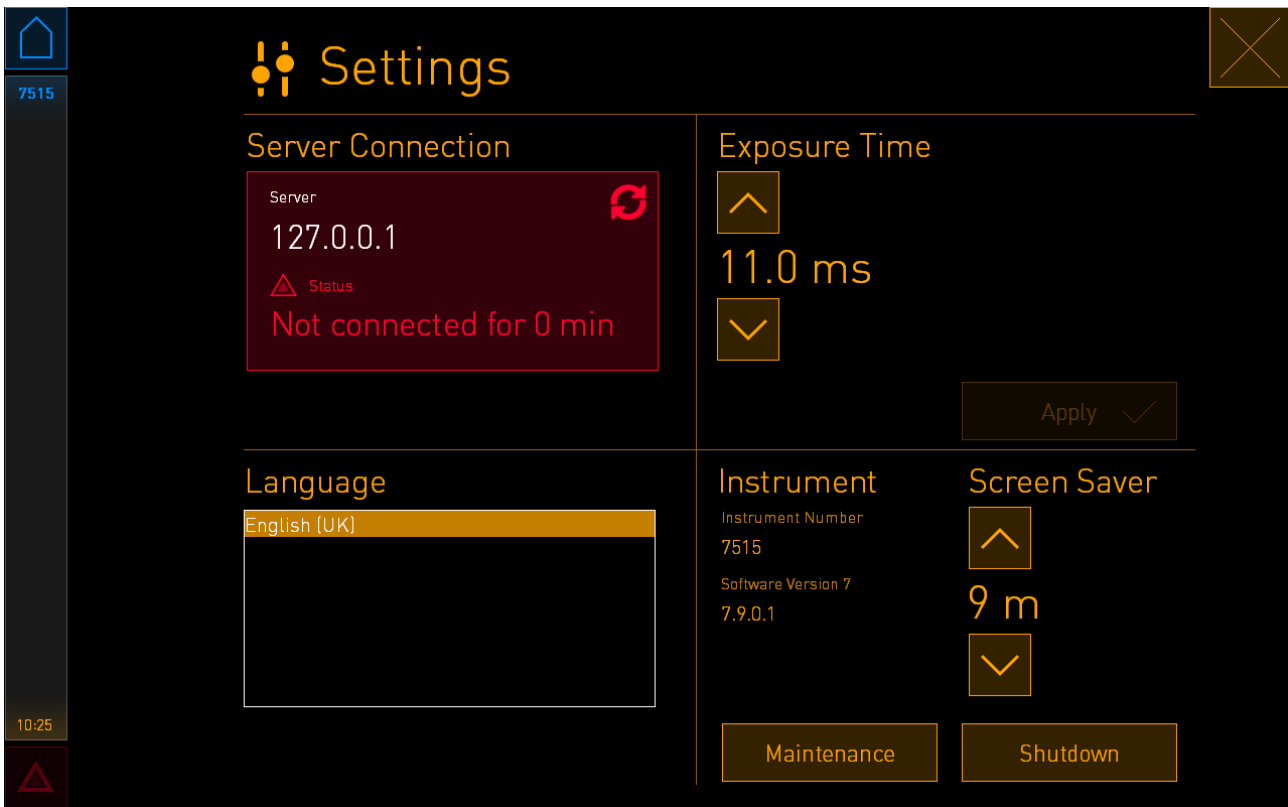

When the connection to the server has been re-established, the red frame will turn green.

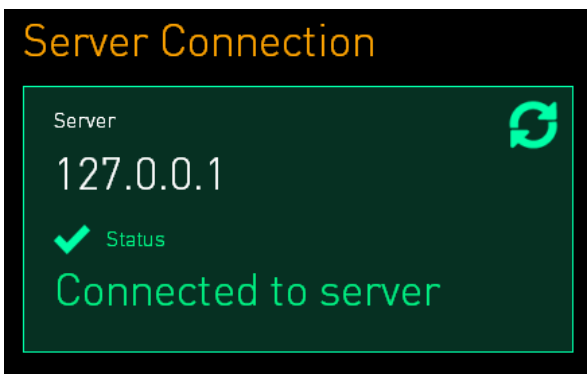

3.3 External alarm output

When the connection between the EmbryoScope 8 incubator and the clinic's internal alarm system is established, this must be supervised by a person certified by Vitrolife. The connection must be thoroughly tested in collaboration with personnel qualified to operate the internal alarm system to ensure that all alarm signals from the EmbryoScope 8 incubator are registered properly by the clinic's alarm system.

For a detailed description of how to connect to an external alarm system, see section 8.10.

3.4 Incubator data

The EmbryoScope 8 incubator is prepared for connection to an external logging system that can monitor the operation of the incubator. The incubation conditions registered by the incubator will be sent to the external system.

3.5 USB connections

The back panel and the panel under the service lid at the top of the EmbryoScope 8 incubator each contain a USB port.

The USB port on the back panel should only be used by persons certified by Vitrolife, e.g. to extract data for Vitrolife support.

The USB port under the service lid can be used by the clinic to extract monthly incubation reports (see section 13.2.2).

4 Operating the EmbryoScope 8 incubator

The EmbryoScope 8 incubator is controlled via two screens:

- The small incubator screen where the operator controls the incubation conditions, i.e. temperature, CO₂ and O₂ concentration.
- The large PC screen where the operator adds and removes culture dishes and from where the data acquisition functions, motors, camera, etc. are controlled.

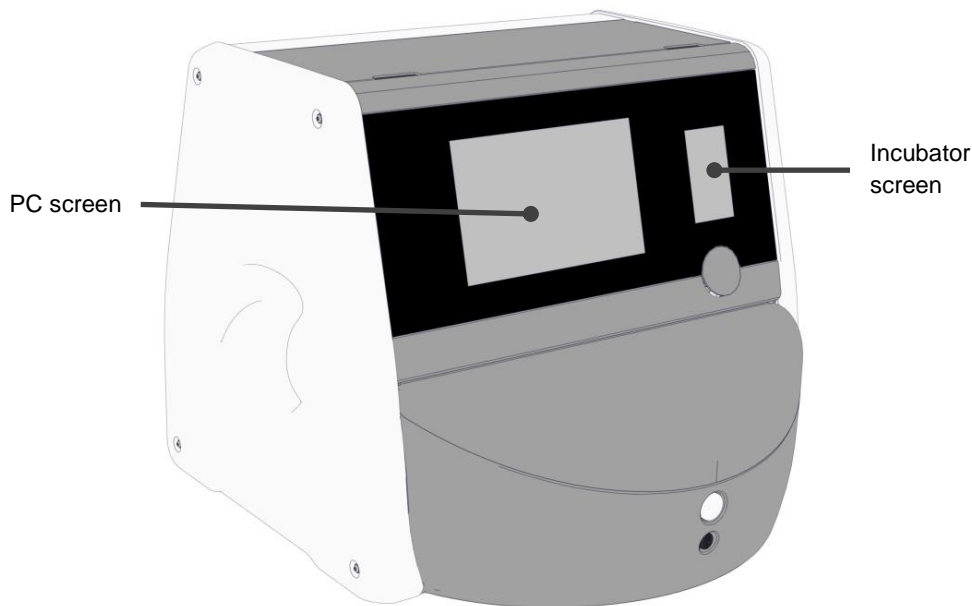

4.1 The incubator screen

The small incubator screen controls the incubation conditions inside the incubator. The incubator screen is used for:

- Inspecting a range of incubation conditions: current temperature, CO₂ concentration and O₂ concentration
- Changing the set point of the individual incubation conditions (see sections 4.1.4.1 and 4.1.5.1)
- Validating the individual incubation conditions and calibrating the EmbryoScope 8 incubator (see sections 4.1.4.2 and 4.1.5.3)
- Turning on or off O₂ regulation (see section 4.1.6.1)
- Pausing auditory warning alarms issued by the EmbryoScope 8 incubator (see sections 8 and 8.2).

4.1.1 Navigating on the incubator screen

When the incubator is in normal operation, the home screen is open. This screen displays the current incubation conditions, i.e. embryo temperature, CO₂ concentration and O₂ concentration:

Home screen

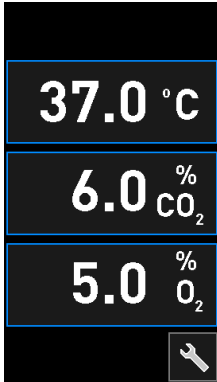

NOTE

- Always leave the incubator with the home screen open.

Navigate on the incubator screen by pressing the buttons surrounded by a blue frame, e.g. the temperature button on the home screen:



You can modify the set point of the incubation conditions or calibrate the internal sensors by using the + and - buttons:



Confirm all changes by pressing the confirmation button:



These buttons are available from the change set point mode and from the calibration mode (see sections 4.1.2 and 4.1.3).

It is always possible to return to the home screen by pressing the close button: .

You can increase and decrease the set point in steps of 0.1 by using the + and - buttons:

Home screen

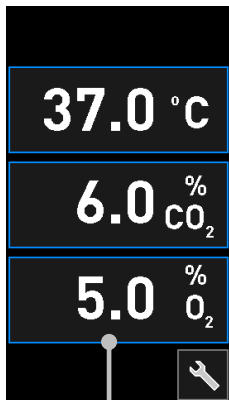

Press one of the incubation conditions to see details

Set point details

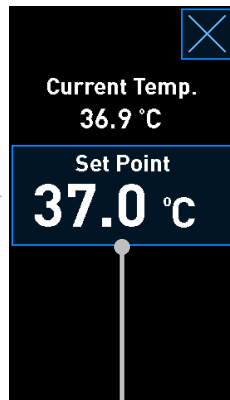

Press the current set point to change it

Change set point mode

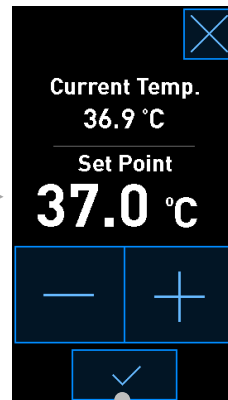

Press the + and - buttons to change the set point, and press ✓ to confirm the changes

4.1.2 Change set point mode

When you press the current value of one of the incubation conditions, further details about the parameter are displayed:

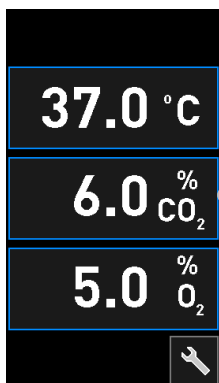

Example: press the current CO₂ to get further details about flow, pressure and set point

This opens the set point details display:

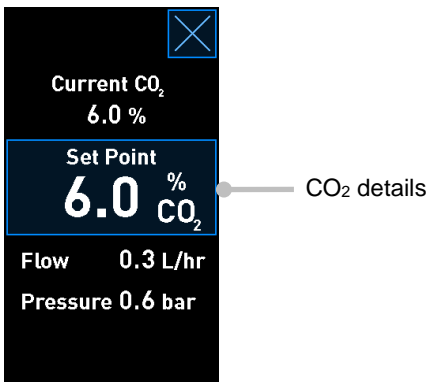

When you open the details display, the large PC screen displays a graph of how the selected parameter has developed over a specific time period. The following example displays a graph of the CO₂ concentration:

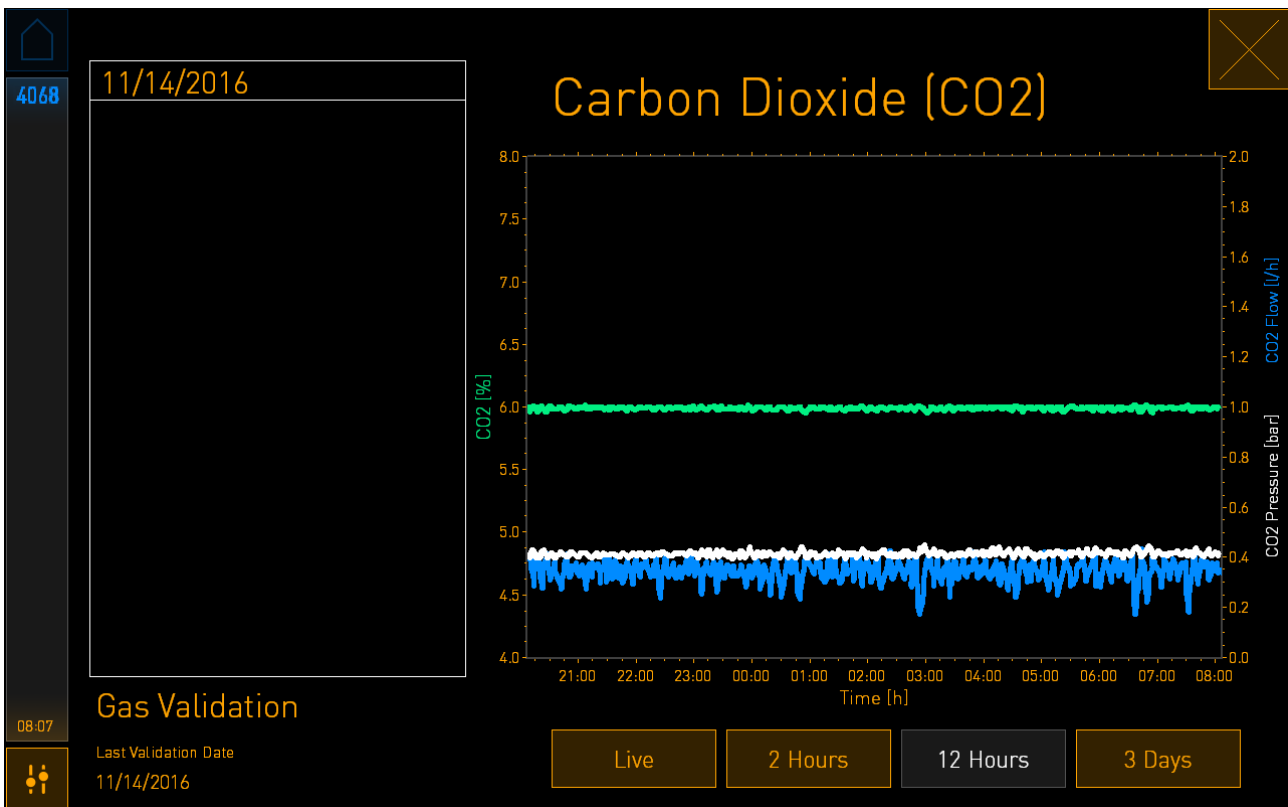

The dotted green line displays the current set point. It may be located behind the varying green graph. The remaining graphs display the CO₂ concentration (varying green graph), flow (blue graph) and pressure (white graph) over a given time period. The default time period is **12 Hours**. Press either **Live** to see a live update of the current CO₂ concentration (continually updated) or **2 Hours** or **3 Days** to change from the displayed time period.

When you have pressed the blue-framed **Set Point** button on the details display, the change set point mode is opened and you can modify the set point:

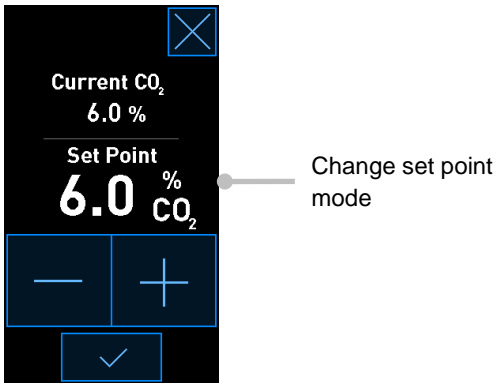

See sections 4.1.4.1 and 4.1.5.1 for further information on how to change set points.

4.1.3 Validation and calibration mode

The validation and calibration mode is used when you want to validate the incubation conditions and afterwards calibrate the internal sensors, if required.

The validation mode is activated when you press the tool button:  on the small incubator home screen:

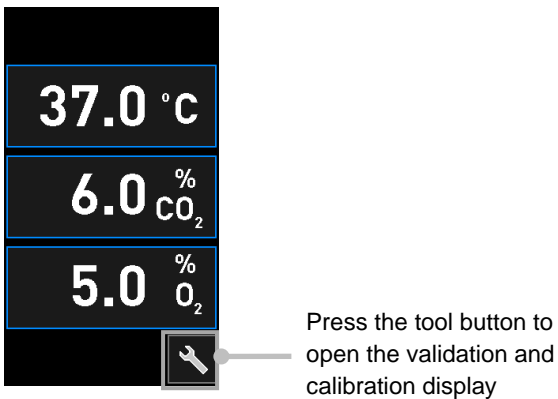

You can start your validation by pressing either **CO₂ and O₂**, **Temp. Sensor A** or **Temp. Sensor B**.

In the following example, temperature sensor B is validated.

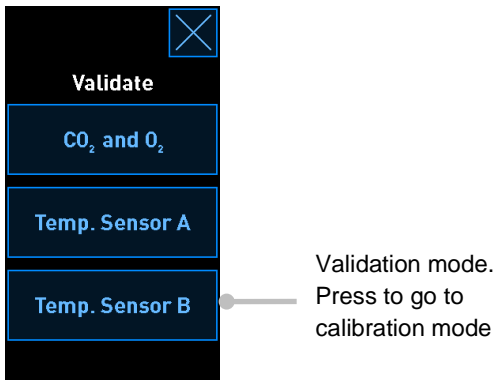

When the validation mode is opened, the large PC screen displays a graph of the selected parameter in **Live** mode. This graph is continually updated, which enables you to verify whether the temperature is stable:

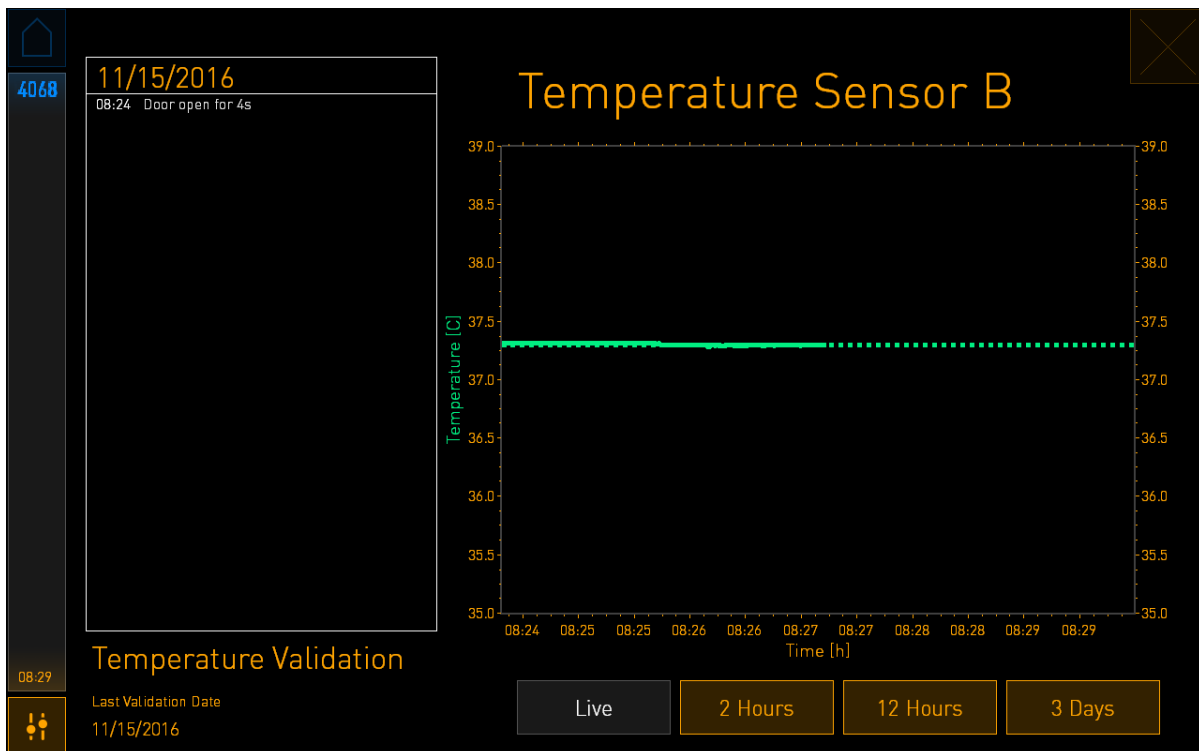

The dotted green line displays the expected dish holder temperature, which should be the target if you need to calibrate the internal sensors. In the above example, the target temperature is 37.3°C. The set point is 37.0°C. Since there is a difference of 0.3°C between the temperature of the dish holder (where the current temperature is measured) and the embryo temperature, the target temperature of your calibration is 37.3°C. In this way, the embryo temperature will correspond to the set point, i.e. 37.0°C.

The other green line displays the current temperature as measured by the internal high-precision thermometer.

When validating the incubator, you insert a temperature probe into the dish holder:

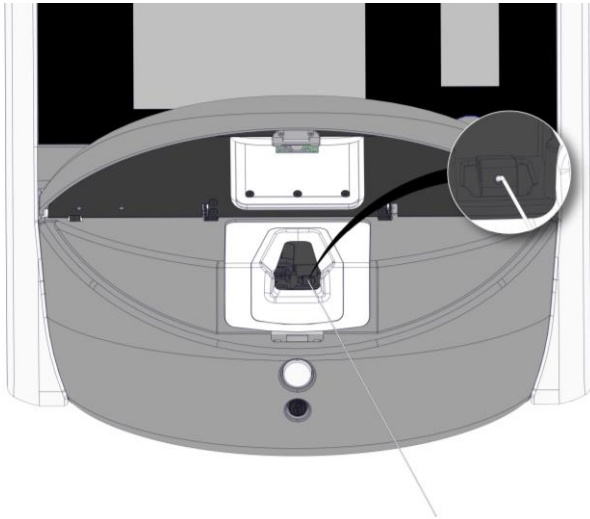

Inserting a temperature probe allows you to compare the temperature displayed on the small incubator screen with the temperature measured by the probe.

If the temperature reading made by the temperature probe deviates from the current internal reading displayed on the small incubator screen, it is necessary to calibrate the temperature.

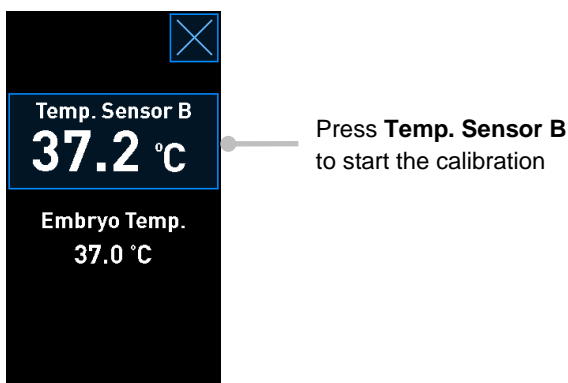

NOTE

- After you have inserted the temperature probe, hold the probe to the right when closing the load door to avoid closing the load door lock directly on the probe.
- Carefully remove the temperature probe after calibration/validation.

See sections 4.1.4.2 and 4.1.5.3 for information on how to calibrate the internal sensors.

4.1.4 Controlling the incubator temperature

4.1.4.1 Changing the temperature set point

1. Press the current temperature to show the set point details:

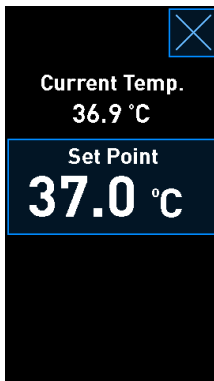

2. Press the blue-framed **Set Point** button.
The change set point mode opens.
3. Press **+** to increase the temperature in steps of 0.1°C, or press **-** to decrease the temperature in steps of 0.1°C:

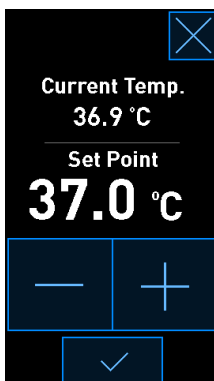

NOTE

- The maximum temperature set point is 39.0°C.
- The minimum temperature set point is 36.0°C.

4. Apply the new setting by pressing the confirmation button:



5. Press the close button to return to the incubator home screen:



4.1.4.2 Calibrating the temperature

The EmbryoScope 8 incubator must have been turned on for at least three hours to achieve full equilibrium before the temperature is calibrated. The room temperature must be equivalent to normal laboratory temperature.

If the temperature reading made by an external high-precision thermometer deviates from the current internal reading displayed on the incubator screen, it is necessary to calibrate the temperature.

WARNING

- The clinic must perform scheduled validation checks at least every two weeks to validate the temperature.

CAUTION

- The image acquisition will stop for all running culture dishes during temperature validation. A temperature validation requires a probe to be inserted into the culture dish holder. Therefore, the system CANNOT automatically resume image acquisition and normal operation until the operator has confirmed that the temperature probe has been removed.

This example covers calibration of temperature sensor B.

Follow this procedure:

1. From the validation mode, press the blue-framed **Temp. Sensor B** button to enter the calibration mode:

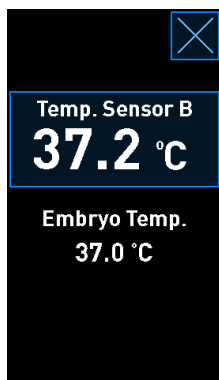

The calibration mode now opens:

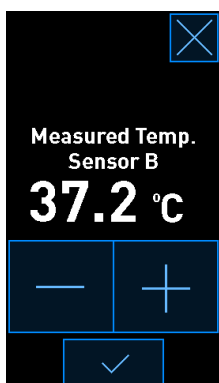

The PC screen displays a graph of the temperature at the current point in time. The graph is displayed in **Live** mode. In this mode, the temperature graph is continually updated:

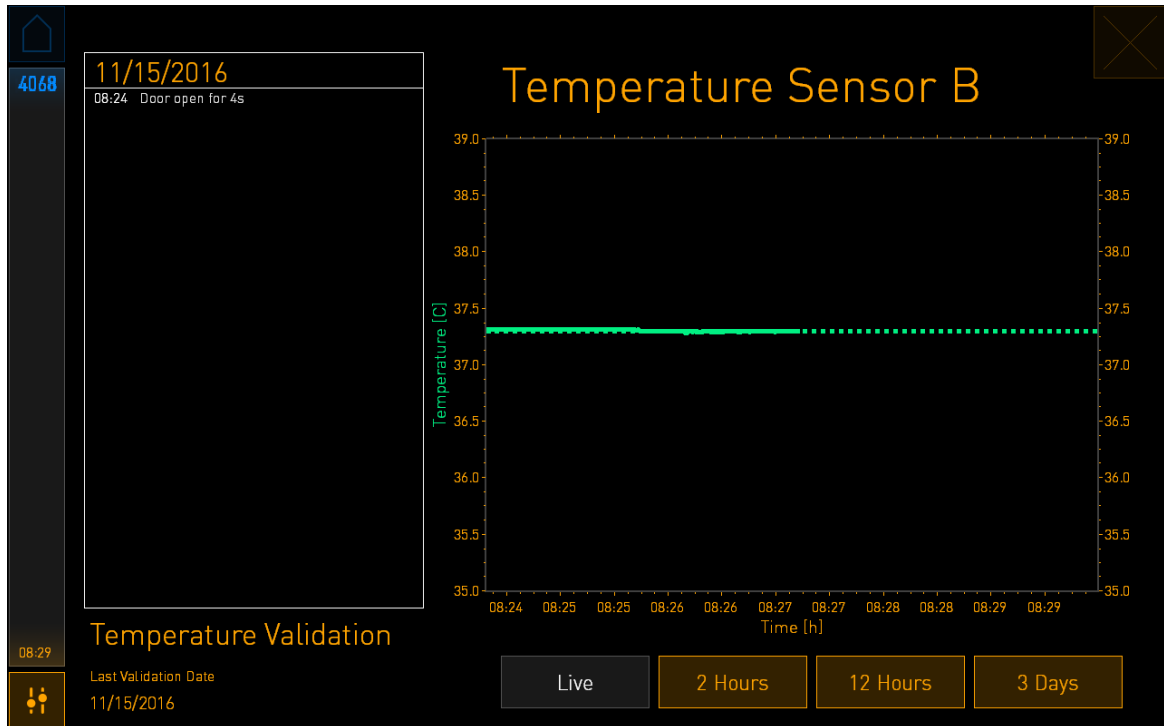



2. Press **+** on the small incubator screen to increase the temperature for sensor B in steps of 0.1°C, or press **-** to decrease the temperature in steps of 0.1°C until the displayed value matches the reading by the external temperature probe.

For example, if the temperature reading made by the external temperature probe is 37.4°C and the current reading made by the internal sensor is 37.2°C, the displayed temperature must be increased by +0.2°C to reflect the **Measured Temp. Sensor B** made by the external temperature probe.

3. Press the confirmation button: .

NOTE

- To discard your changes and return to the incubator home screen without applying any changes, press  *without* first pressing the confirmation button. Then select **No** in the displayed message.

4. After three minutes, when the graph on the PC screen displays a stable temperature regulation, validate the temperature by using the temperature probe.
 - a) If the external temperature reading and the internal reading are now identical, press  to exit validation mode. Remove the temperature probe and confirm that you have indeed removed it. Then return to the incubator home screen.
 - b) If the temperature reading made by the temperature probe and the current internal reading as displayed on the small incubator screen still do not match, repeat the calibration procedure by following steps 1-3.

WARNING	
<ul style="list-style-type: none">• Always validate the incubator temperature after calibration.	

4.1.5 Controlling the CO₂/O₂ concentration

4.1.5.1 Changing the CO₂/O₂ set point

1. Press the current CO₂/O₂ concentration to open the set point details:

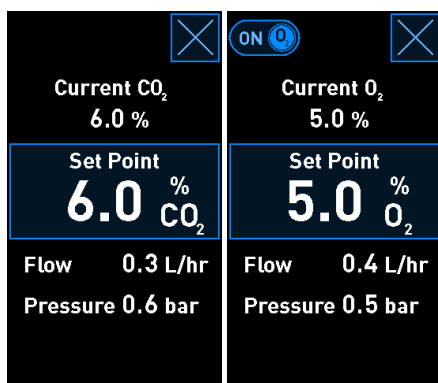

2. Press the blue-framed **Set Point** button.

- Press + to increase the gas concentration in steps of 0.1%, or press - to decrease the gas concentration in steps of 0.1%:

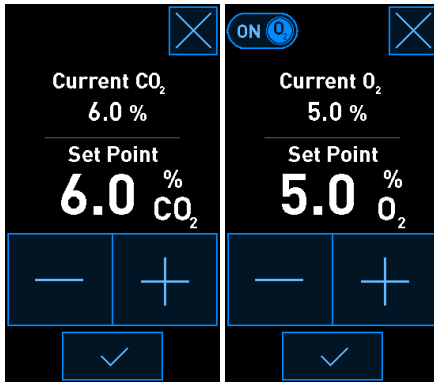

These are the minimum and maximum set points (not applicable when ambient oxygen is used):

	Minimum	Maximum
CO₂	3.0%	8.0%* 12.0%**
O₂	4.0%	8.0%

* Incubators with serial numbers below 4343. ** Incubators with serial numbers 4343 and above.

- Press the confirmation button: 

- Press the close button to return to the incubator home screen: 

4.1.5.2 Validating the CO₂/O₂ concentration

WARNING

- The clinic must perform scheduled validation checks at least once every two weeks to validate the gas concentrations.

Before the CO₂/O₂ concentration is validated, the EmbryoScope 8 incubator must have been turned on for at least three hours with the appropriate gasses connected to ensure that full equilibrium is attained. The room temperature must be equivalent to normal laboratory temperature.

Before you start, make sure that the gas analyser is calibrated according to the manufacturer's specifications.

To validate the gas concentration:

1. Switch on the gas analyser used for measuring the CO₂/O₂ concentration.
2. Press the tool button:  on the incubator home screen.
3. Press **Validate CO₂ and O₂** to start the validation. On the PC screen, a graph of the CO₂/O₂ in **Live** mode will be displayed:

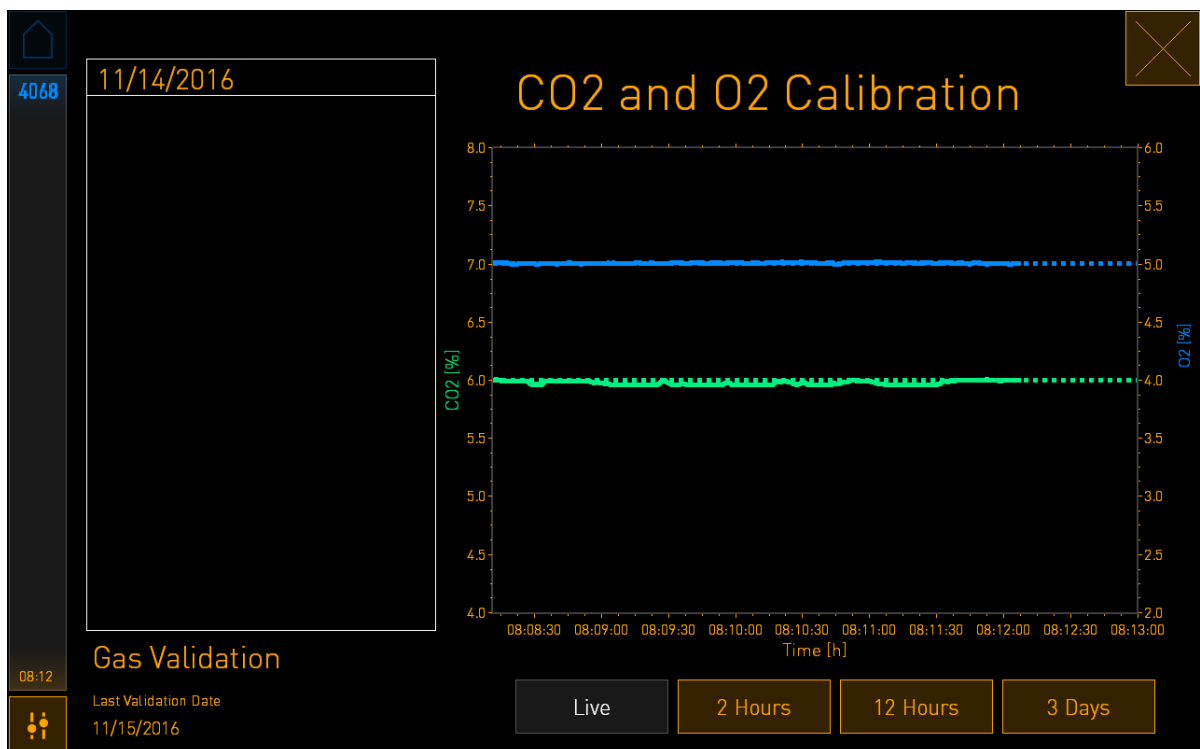

4. Remove the cover from the gas sample port:

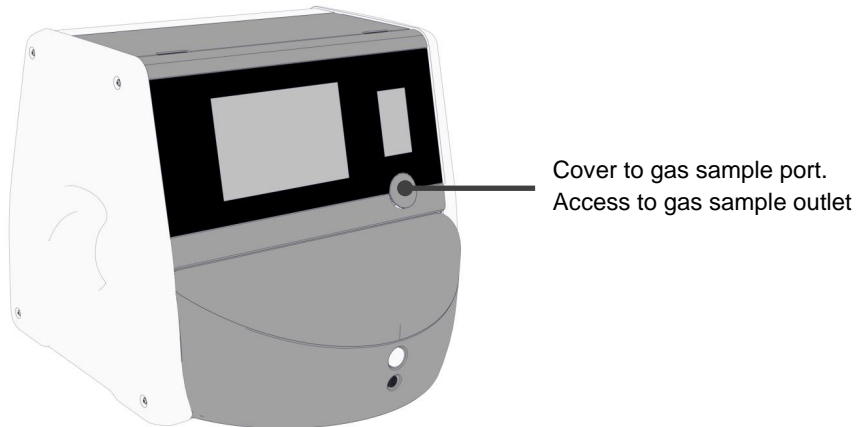

5. Attach the tube from the gas analyser to the gas sample outlet:

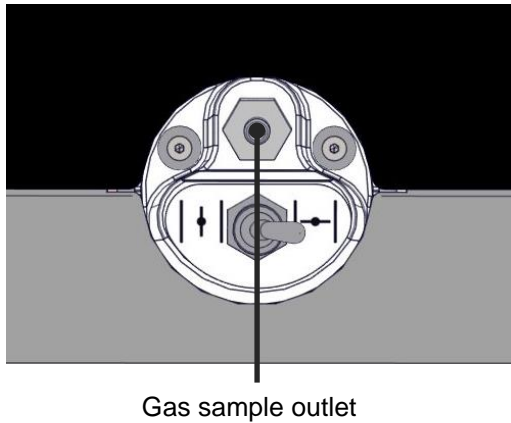

6. Open the valve to withdraw a sample. The valve is open when the switch is turned to the left:

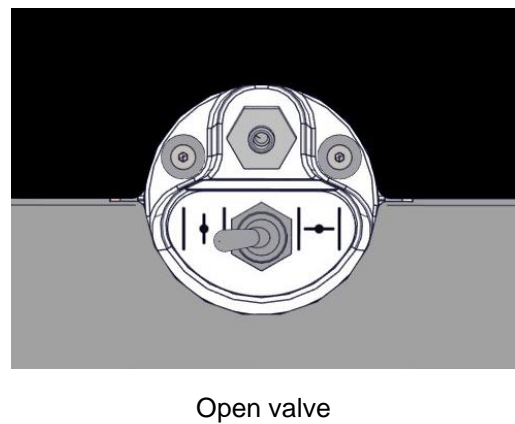
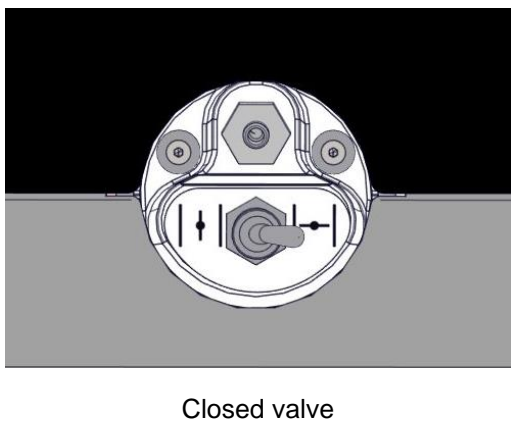

The screen displays the current CO₂/O₂ reading:

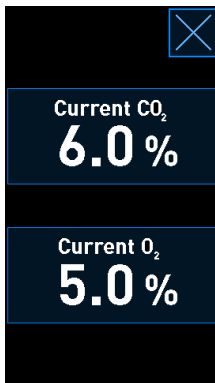

7. Compare the reading made by the external gas analyser with the current reading displayed on the incubator screen.
8. Either calibrate the gas concentration or return to the incubator home screen:
 - a) In case the reading made by the external gas analyser and the current internal reading displayed on the screen differ by more than 0.1%, the gas concentration must be recalibrated. See how to calibrate the gas concentration in section 4.1.5.3.
 - b) If there is no need to calibrate the gas concentration, press .

4.1.5.3 Calibrating the CO₂/O₂ concentration

The EmbryoScope 8 incubator must have been turned on for at least three hours to achieve full equilibrium before the gas concentration is calibrated.

If the reading made by the external gas analyser deviates from the current internal reading displayed on the screen, it is necessary to calibrate the internal gas sensors.

Follow this procedure:

1. Validate the CO₂/O₂ concentration as specified in section 4.1.5.2.
2. Press the blue-framed **Current CO₂/Current O₂** button to start the calibration:

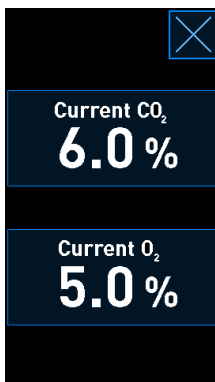

The calibration details display now opens:

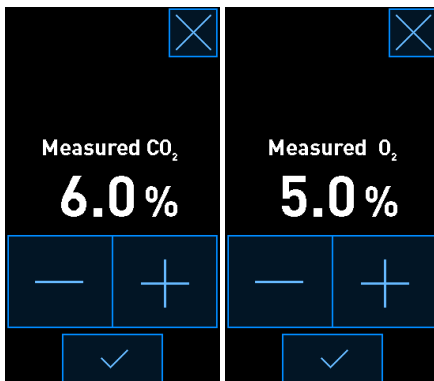

The PC screen displays a graph of the CO₂/O₂ concentration at the current point in time. The graph is displayed in **Live** mode. In this mode, the graph is continually updated:

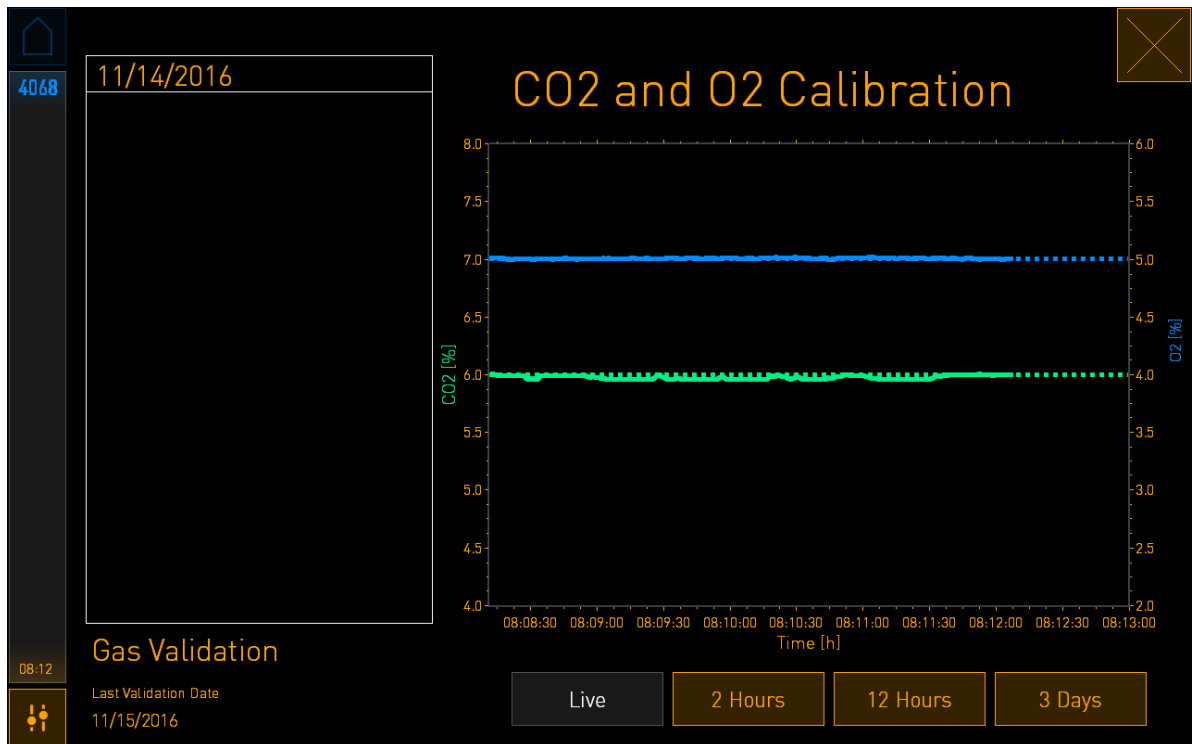



3. Press **+** on the small incubator screen to increase the gas concentration in steps of 0.1%, or press **-** to decrease the gas concentration in steps of 0.1% to match the values on the external gas analyser.

For example, if the concentration measured by the external gas analyser is 6.2% and the current reading by the internal sensor is only 5.9%, the displayed concentration must be adjusted by +0.3% to reflect the measured concentration of 6.2%.

4. Press the confirmation button: .

NOTE

- To discard your changes and return to the incubator home screen without applying any changes, press  *without* first pressing the confirmation button. Then select **No** in the displayed message.

5. After 10 minutes, when the graph on the PC screen displays a stable gas regulation, validate the concentration by using the external gas analyser.
 - a) If the external reading and the displayed internal reading are identical or differ only by 0.1%, press  to exit validation mode. Return to the incubator home screen.
 - b) If the reading made by the external gas analyser and the current internal reading displayed on the small incubator screen differ by more than 0.1%, repeat the calibration procedure by following steps 1-3.

WARNING

- Always validate the gas concentration after calibration.

4.1.6 Incubator O₂ regulation

4.1.6.1 Turning on/off the O₂ regulation

1. Press the current O₂ concentration to open the set point details:

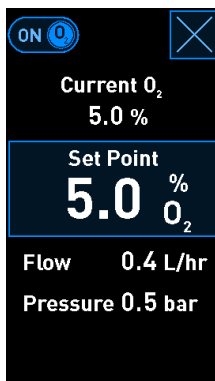

2. Move the slider to **ON** if you want to activate the O₂ regulation, OR Move the slider to **OFF** if you want to deactivate the current O₂ regulation.
3. Confirm your changes by pressing **Yes** in the displayed message.

4.2 The PC screen

4.2.1 PC home screen

The PC home screen of the EmbryoScope 8 incubator provides an overview of all culture dishes that have been placed inside the incubator (see the following screen shot). Each patient may have more than one culture dish and thus be represented more than once in the overview. From all other screens, you can always return to the PC home screen by pressing this icon:



From the PC home screen, you can:

- Select a patient and get an overview of a particular culture dish (see section 4.2.2)
- Start a new culture dish (see section 4.2.1.2)
- Access the **Settings** screen where you can:
 - Check the connection to the ES server
 - Change the language settings
 - Set the camera exposure time
 - See the current software version of the incubator
 - Enable or disable the screen saver
 - Access the maintenance options
 - Shut down the PC.

4.2.1.1 Colours on the home screen

The following colours are used on the home screen:

White: The EmbryoScope 8 incubator is performing the autofocus procedure for the culture dish prior to starting the image acquisition OR this is an equilibration dish that has not yet completed.

Orange: The EmbryoScope 8 incubator is acquiring images from the culture dish.

Green: The equilibration dish is completed and ready for use OR the culture dish contains one or more embryos selected for transfer.

Red: The equilibration dish or culture dish is overdue and should be removed from the EmbryoScope 8 incubator. If you press an overdue culture dish, the last image acquired from the embryo will be displayed.

Home button

Instrument number

Wells containing embryos in this culture dish. The EmbryoScope 8 incubator is performing the autofocus procedure for this culture dish prior to starting the image acquisition

Patient ID

750

5 Andy Stephenson 9753

3 Amy Barret 2345

2 Amy Sanders 4689

0 Jaqueline Daubney 0987

Equilibrated Overdue

Equilibrated OK

Equilibrating 1.1 h

13:48

+

Add Culture Dish

Days after insemination

Add Culture Dish button. Unavailable when there are no more free positions

Running equilibration dish

Completed equilibration dish

Equilibration dish that has been equilibrating for longer than the maximum time period defined by the user

Running culture dish. If you have selected at least one embryo for transfer via the EmbryoViewer, the culture dish will appear in green colour

The incubator automatically detects if any bubbles are present in the wells. Bubbles are indicated by a red circle around the well in question, and no other alarms or warnings are triggered:



4.2.1.2 Starting a culture dish

Make the following preparations before starting a culture dish:

- Create the relevant treatment and enter the patient information in the EmbryoViewer. From the **Patient Details** page of the EmbryoViewer, print one or more barcode labels for this patient.
- Prepare the culture dish as specified in the user manual for the culture dishes.

The culture dish is now ready to be inserted in the EmbryoScope 8 incubator. The incubator will automatically scan and register the patient name, patient ID and treatment ID, provided that the incubator is connected to the ES server. If there is a problem reading the barcode, see section 4.2.1.3.

NOTE

- The load door to the incubation chamber is locked when the orange lock indicator light is turned on. When the culture dish holder has been moved to loading position and the load door can be opened, the lock indicator changes to a pulsating white light.

To start a culture dish:

1. On the PC home screen, press the **Add Culture Dish** button.

The lock indicator light at the front of the incubator will change from orange to a pulsating white colour indicating that the door is unlocked and can be opened.

2. Open the load door and place the culture dish in the accessible position of the holder.

The EmbryoScope 8 incubator keeps track of unoccupied positions and will automatically move the culture dish holder to the next free position. The culture dish should be inserted with the handling fins and barcode label towards the operator:



3. Close the load door and confirm that you have inserted the culture dish.

The culture dish has now been inserted, and the barcode reader automatically registers the patient and treatment information from the barcode label.

4. Specify which type of culture dish you have inserted, and press **Yes** to confirm the patient's identity:

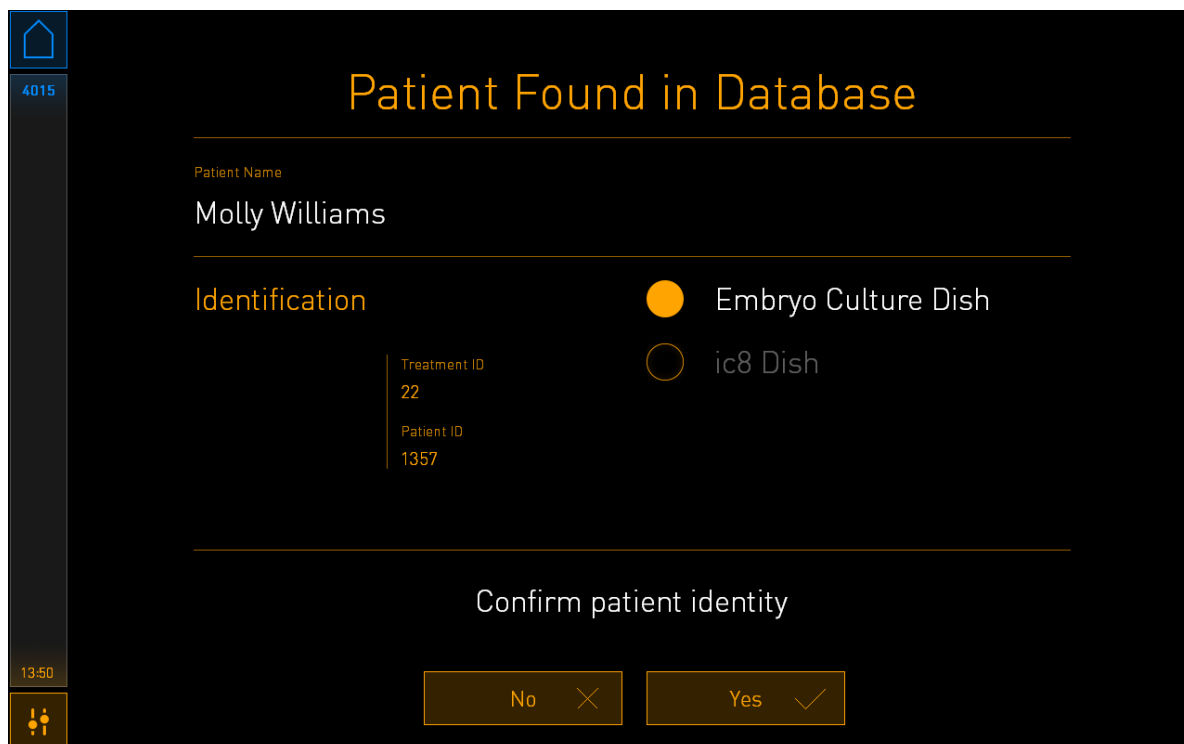

If the barcode cannot be read, the following screen will appear:

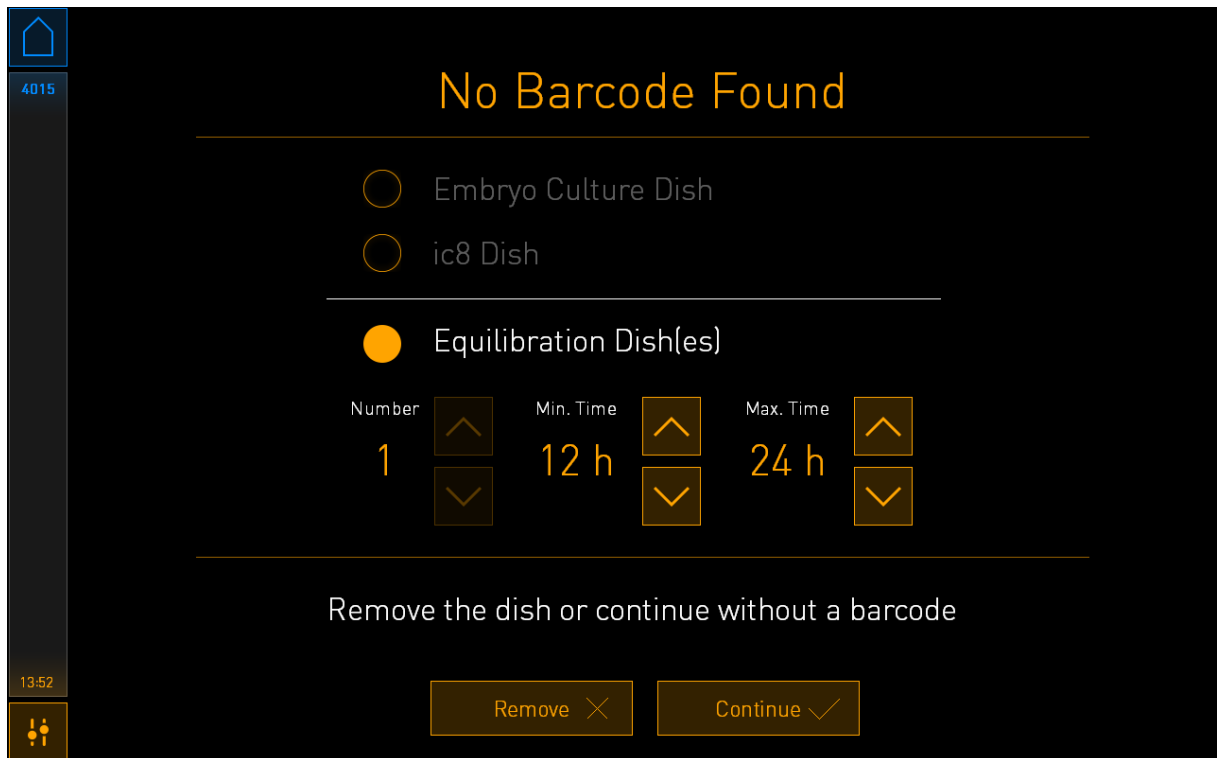

The **Equilibration Dish(es)** radio button is selected by default. Select the **Embryo Culture Dish** radio button or the **ic8 Dish** radio button to indicate that you have inserted a culture dish, and press the **Continue** button. Enter the required patient and treatment information manually by using the keyboard that appears on the screen, and press **Done**.

See section 4.2.1.3 for further information on possible barcode errors.

NOTE

- If you have placed the culture dish in the dish holder and do NOT want to insert the dish after all, press the home icon  or the **Remove** button. Then remove the culture dish and press **Yes** to confirm that the dish has been removed.

5. Enter the date and time of insemination. You will not be able to continue without entering the date and time of insemination.

- Indicate which wells you want to acquire images from (all wells containing embryos). All wells are selected by default. Press the wells that you want to exclude from the image acquisition.



- Press **Done**. This button is dimmed until you have entered the date and time of insemination.



Allow a few minutes for the autofocus procedure to determine the optimal focal planes for all selected wells.

When the focal planes have been adjusted, the EmbryoScope 8 incubator will automatically proceed with the image acquisition.

NOTE

- The image acquisition stops for all running culture dishes while a new dish is being inserted. The image acquisition will automatically resume when the autofocus procedure is complete.

4.2.1.3 Barcode errors

When you insert a culture dish, the barcode reader will automatically attempt to detect a barcode on the culture dish.

If the barcode reader is not functioning properly, or if the barcode is damaged or missing, a message will be displayed on the screen.

The following table lists the messages that may occur when barcodes are used and describes how you should respond to each of them:

No.	Message	Cause	Solution
1	There is no barcode on the inserted culture dish. Enter patient and treatment information manually.	The barcode reader was unable to detect a barcode on the inserted culture dish.	<ul style="list-style-type: none"> • Print a barcode from the EmbryoViewer and apply it to the culture dish. Then reinsert the culture dish. • Insert the culture dish without a barcode and manually enter the patient information from the keyboard on the PC screen.
2	There was a problem reading the barcode. Enter patient and treatment information manually.	The barcode may be damaged, wrinkled or unintelligible.	<ul style="list-style-type: none"> • Check that the barcode is applied correctly without any wrinkles. • Check that there is printing foil in the printer you use for barcodes.
3	No connection to the ES server. Enter patient and treatment information manually.	The server may not be running, or there may be a problem in establishing a connection to it.	<ul style="list-style-type: none"> • Establish a connection to the ES server. Then remove the culture dish from the incubator and end the process by re-inserting it. • Insert the culture dish and manually enter the patient and treatment information from the keyboard on the PC screen.

No.	Message	Cause	Solution
4	<p>Not possible to use the barcode reader.</p> <p>The system will continue without barcodes.</p> <p>When barcodes are not used, the system will not be able to automatically resume image acquisition in case of a power failure.</p>	<p>The barcode reader is currently not functional.</p>	<ul style="list-style-type: none"> • Continue without barcodes. • Restart the PC by pressing the reset button under the service lid twice (follow the procedure in section 2.5). • Shut down the entire incubator by pressing the Shutdown button on the PC screen (follow the procedure in section 2.4).
5	<p>There is a duplicate barcode on the inserted culture dish. Print a new unique barcode for the treatment and place on the dish before inserting.</p>	<p>A culture dish with an identical barcode is running in the same or another incubator.</p>	<ul style="list-style-type: none"> • Print a new unique barcode from the EmbryoViewer and apply it to the culture dish. Then reinsert the culture dish.
6	<p>There is a dish from an incompatible instrument. Culture in this dish cannot be resumed in an incompatible instrument.</p>	<p>A culture dish that was originally running in one type of incubator has been inserted in an incubator of an incompatible type.</p>	<ul style="list-style-type: none"> • Insert the culture dish in an incubator that is compatible with the originating incubator. The incubator is compatible if the culture dish fits correctly into the culture dish holder.

4.2.1.4 Removing a single culture dish

Follow this procedure to remove a culture dish either permanently or e.g. to change medium:

1. From the PC home screen, press the culture dish you want to remove.
2. Move the slider to the right to place the culture dish holder in load position.



Slide to the right to remove the culture dish

3. When a message informs you that the incubator is ready, press the unlock button at the front to open the load door.
4. Remove the available culture dish and close the load door.

NOTE

- The image acquisition stops for all running culture dishes while the dish is being removed. The image acquisition will automatically resume when you close the load door.

4.2.1.5 Removing all culture dishes

1. On the PC home screen, press the settings icon and select **Shutdown**.
2. Select **Remove all culture dishes and shut down**.
3. Remove the culture dishes one by one. Follow the instructions on the screen.

4.2.1.6 Resuming culture in a culture dish

You can resume culture in a culture dish if the incubator is connected to an ES server. Culture can be resumed in the same incubator or in another compatible incubator.

If you have removed a culture dish with a barcode from the incubator and re-insert it, you must indicate which wells are active (all wells from which you want to acquire images). The wells for which image acquisition was disabled (see section 4.2.2.1) before you removed the culture dish will be dimmed. You can deselect additional wells from this screen by pressing the well numbers, e.g. if you have removed the embryos for freezing. Press **Yes** when you have selected all active wells.



If you attempt to insert a culture dish in an incompatible incubator, you will see the following screen. Press **OK** to close this screen.

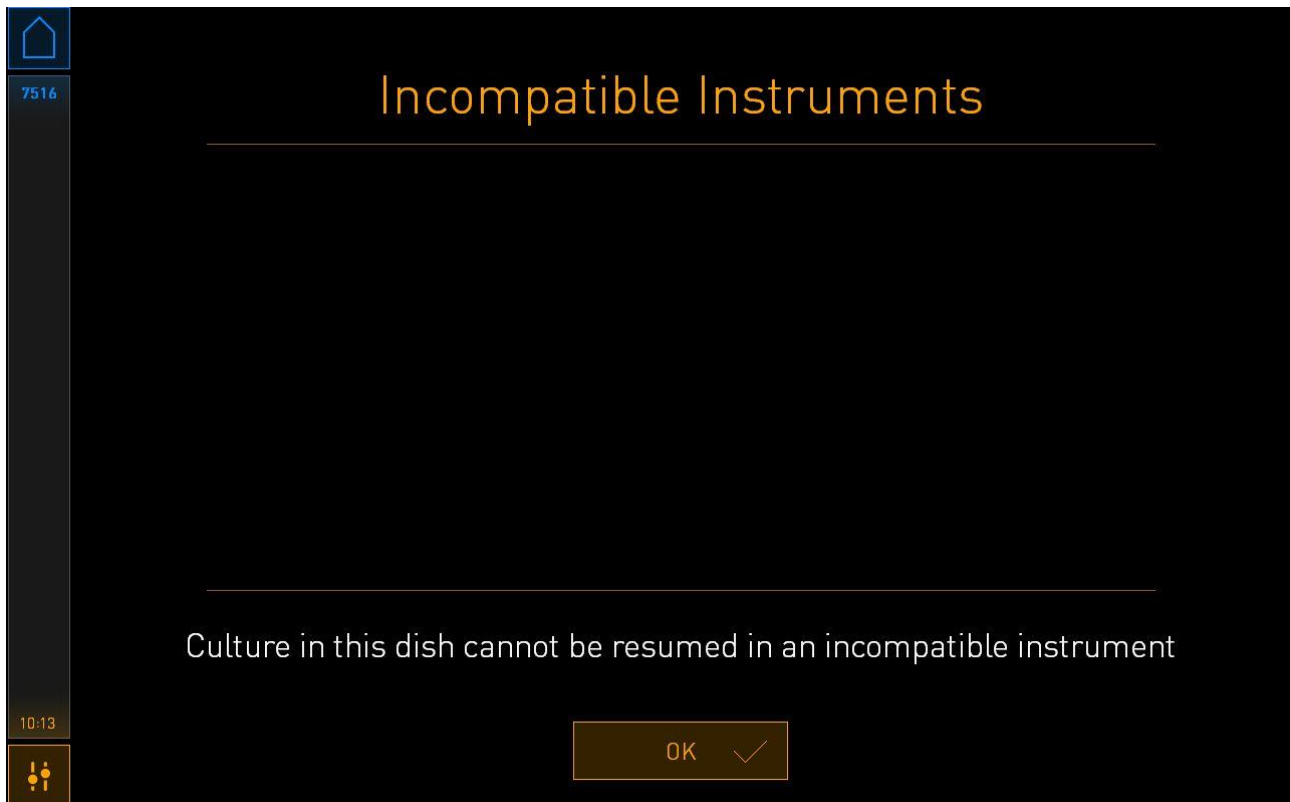

4.2.2 Culture dish overview screen

The culture dish overview screen contains general information that allows the operator to monitor the embryo development.

To open the culture dish overview screen from the PC home screen, select a culture dish by pressing the corresponding button on the home screen.

When the screen is opened, the latest image acquired from each well of the selected culture dish is displayed:

Hours since insemination

General information on the current culture dish

Well with embryo selected for freezing

Well with fresh embryo selected for transfer

Well with frozen embryo selected for transfer

Well with embryo selected to be avoided

Empty well

Press one of the wells to see an enlarged image of the embryo:

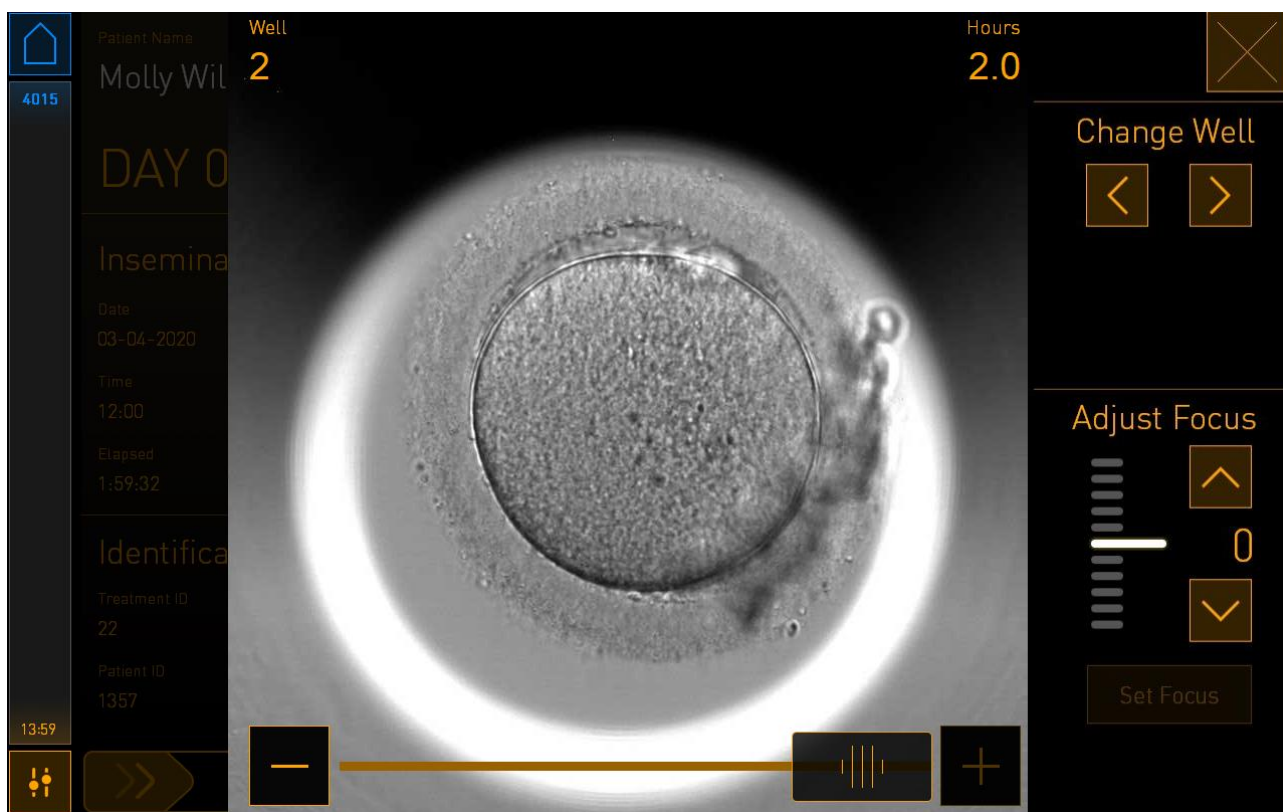

You can use the slider at the bottom of the screen to move between the images in the image series. Press the + and - buttons on each side of the slider to move one image forward or back, or drag the slider to move several images forward or back.

Press the arrows under **Change Well** to go to the previous or next well in the culture dish, or adjust the focus with the arrows under **Adjust Focus**.

To return to the culture dish overview screen, press the close button in the top right corner of the screen.

4.2.2.1 Disabling image acquisition for individual wells

If you want to disable image acquisition for specific wells, press the camera symbol on the culture dish overview screen:



The camera symbol turns white, and you can now press the X for each of the wells that you want to exclude from the image acquisition:

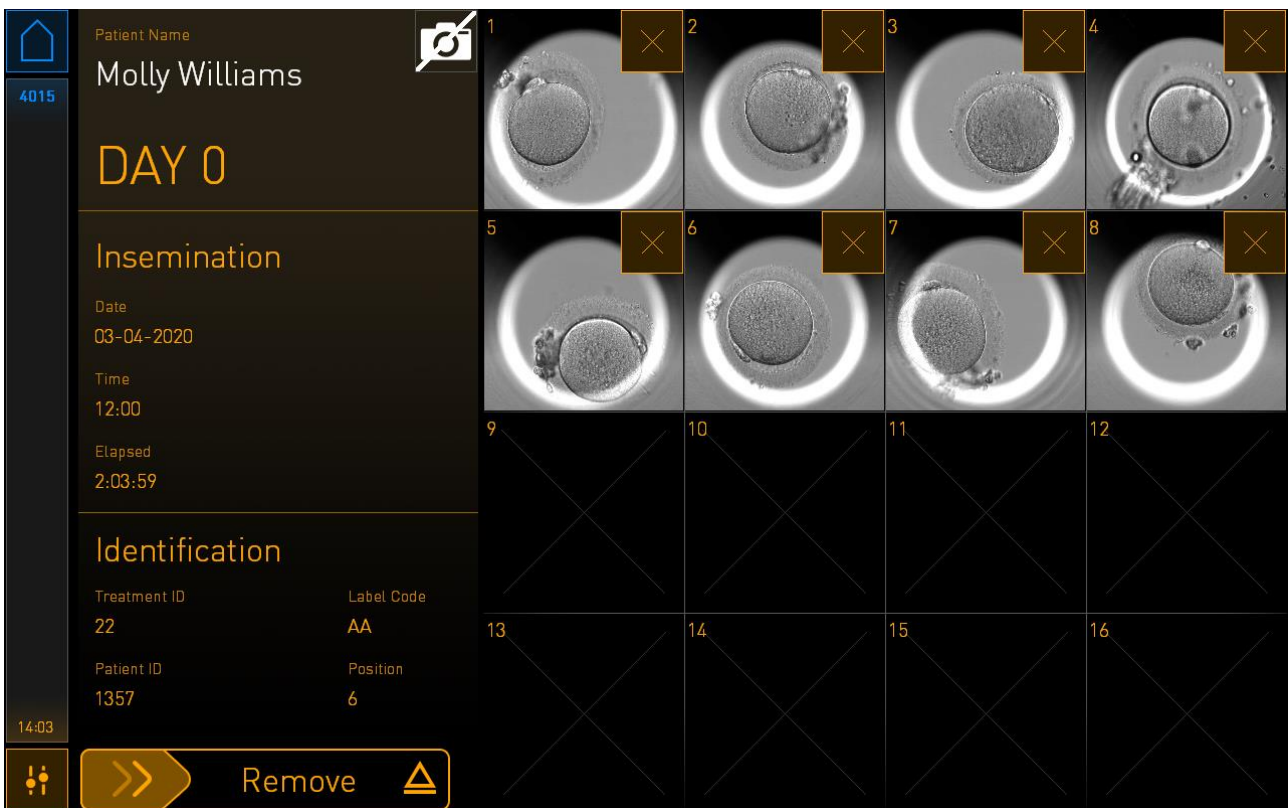

When you press the X for a specific well, you will be prompted to confirm that you want to disable image acquisition for this well. Press **OK** to confirm your choice. When you have selected all the wells that you want to exclude, press the camera symbol again to return to the culture dish overview screen.

4.2.3 Settings screen

On the **Settings** screen, you can verify the connection to the server and re-establish the connection if necessary, choose between available display languages, set the exposure time for the time-lapse images and see the instrument number and software version of the incubator. You can also enable or disable the screen saver and set the idle time period after which the screen saver will be activated. Furthermore, you can access the maintenance options or shut down the system and initiate the emergency procedure (see section 9).

To open the **Settings** screen, press the settings icon: .

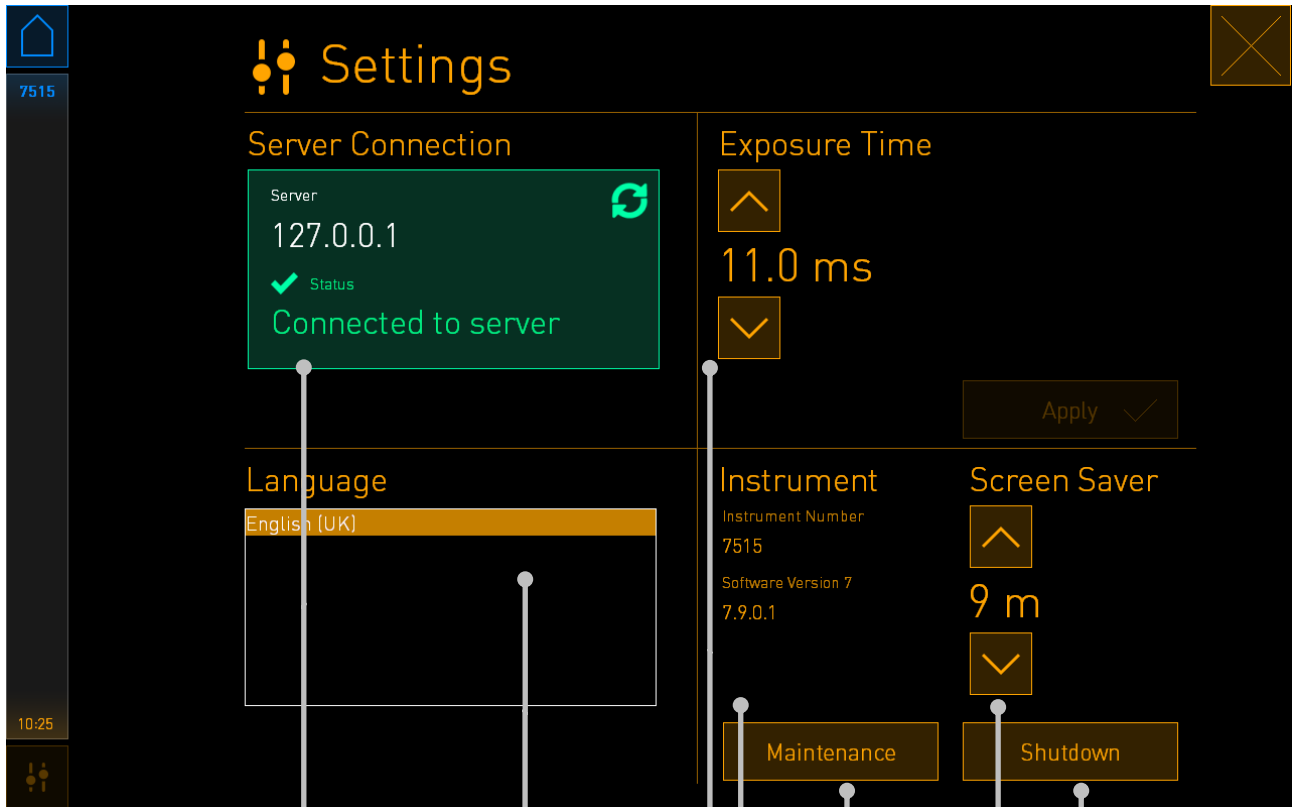

4.2.3.1 Enabling and disabling the screen saver

On the **Settings** screen, you can enable or disable the screen saver. If the screen saver is disabled, the text **OFF** is displayed under **Screen Saver**. Press the arrow up to enable the screen saver:

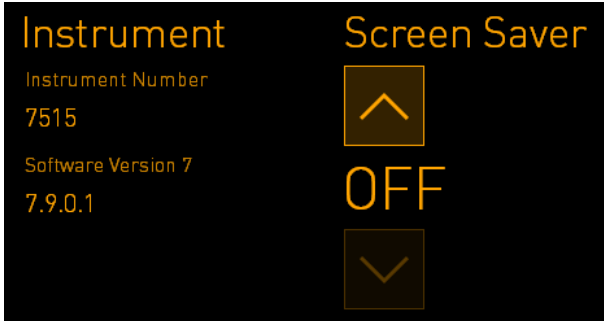

Use the arrows to set the idle time period after which the screen saver will be activated, e.g. 15 minutes:

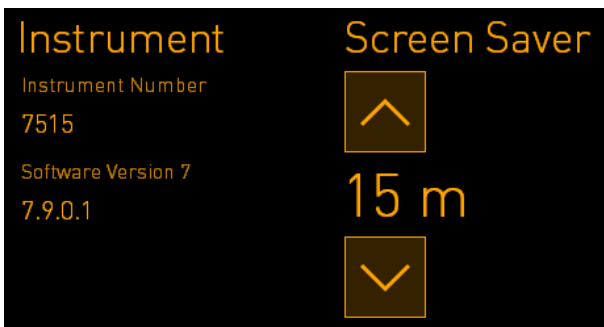

If you want to disable the screen saver, press the arrow down until the displayed setting changes to **OFF**.

5 Cleaning and disinfecting the EmbryoScope 8 incubator

The periodic cleaning procedure is recommended for routine maintenance. The cleaning procedure and the disinfection procedure are also recommended for event-related concerns such as oil spills, visual stains or other evidence of contamination. It is strongly recommended to clean and disinfect the EmbryoScope 8 incubator immediately after any media or oil spills.

5.1 Periodic cleaning of the EmbryoScope 8 incubator

WARNING

- Never clean the EmbryoScope 8 incubator with embryos inside.

Wearing gloves and using good handling techniques are important to successful cleaning. Follow this procedure to clean the EmbryoScope 8 incubator:

1. On the PC screen, press the settings icon. Then press **Shutdown** and remove all running culture dishes individually.
2. Check on the screen that all culture dishes have been removed.
3. Turn off the incubator by pressing the main power switch on the back.

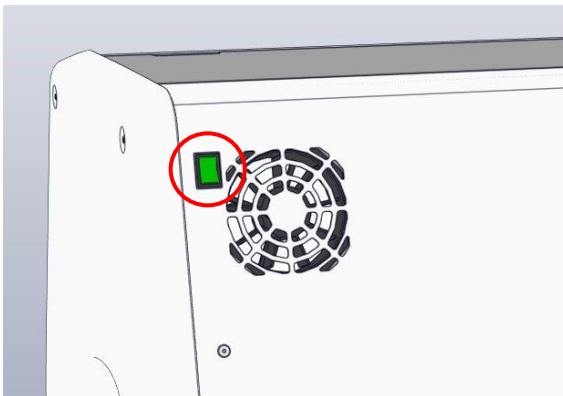

4. Unlock the load door by pressing the emergency unlock button.

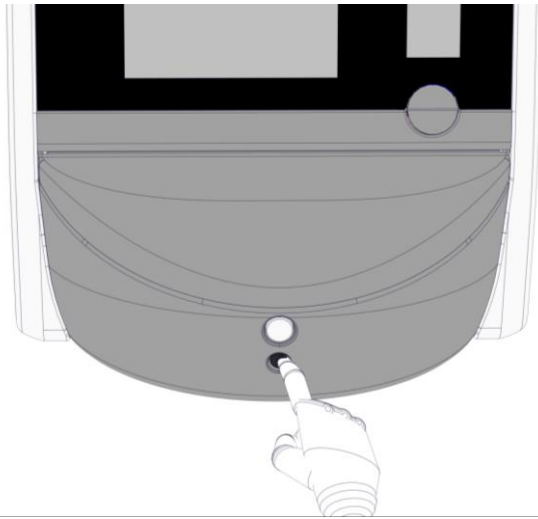

5. Open the load door to the incubation chamber by pressing the white load door open button.
6. Check whether any more culture dishes remain inside the incubator. If one or more dishes remain, remove them as described in the emergency procedure in section 9.
7. Remove the load area frame.

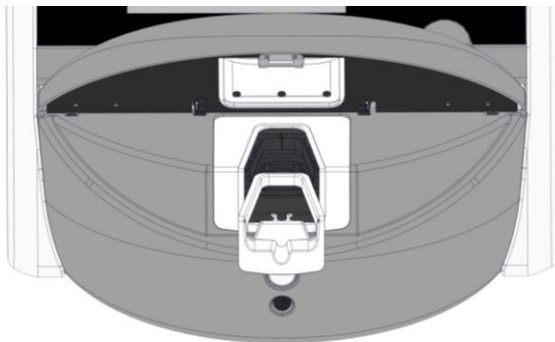

8. Moisten a lint-free tissue wipe and clean all internal and external surfaces of the EmbryoScope 8 incubator.

It is recommended that the incubator and culture dish holder are first cleaned with clean, distilled water, then with aqueous 70% ethanol, and finally with distilled water again.

9. Use both lint-free tissue wipes and lint-free cotton buds to clean the culture dish holder.

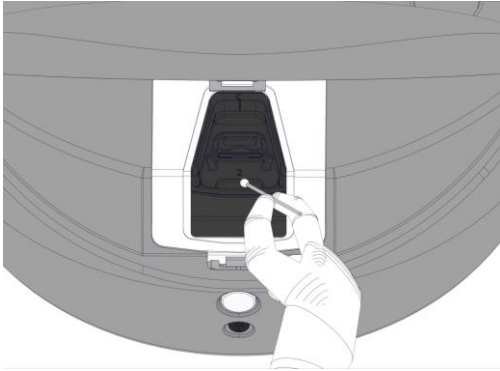

10. Manually rotate the culture dish holder to the next position until all positions have been cleaned.

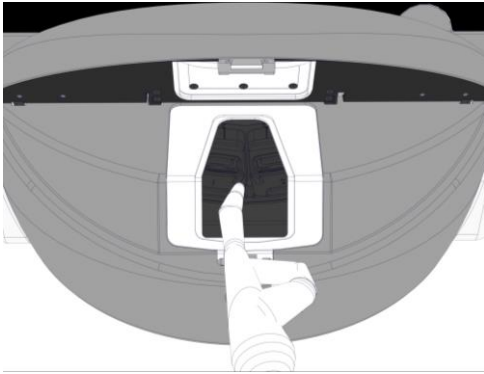

11. After completing the cleaning procedure, leave the load door open long enough for all alcohol fumes to dissipate (minimum 10 minutes).
12. Moisten a lint-free tissue wipe and clean the load area frame.
It is recommended that the frame is first cleaned with clean, distilled water, then with aqueous 70% ethanol, and finally with distilled water again.
13. Make sure that the load area frame is completely dry and that all traces of the used cleaning agent have evaporated. The reinsert the load area frame.
14. Apply clean, distilled water to lint-free tissue wipes and wipe the surfaces of the EmbryoScope 8 incubator.
15. Inspect the EmbryoScope 8 incubator. If the incubator is visually clean, it is ready for use. If it is not visually clean, go to step 7 and repeat the periodic cleaning procedure.
16. After cleaning, turn on the EmbryoScope 8 incubator by pressing the main power switch found on the back. Leave the EmbryoScope 8 incubator running with no embryos inside for at least three hours before re-inserting any culture dishes.

5.2 Disinfection of the EmbryoScope 8 incubator

WARNING

- Never disinfect the EmbryoScope 8 incubator with embryos inside.

NOTE

- Use a disinfectant that is in accordance with laboratory policy.

Wearing gloves and using good handling techniques are important to successful cleaning.

Follow the below procedure to disinfect the EmbryoScope 8 incubator in case of contamination and/or spillage.

1. On the PC screen, press the settings icon. Then press **Shutdown** and remove all running culture dishes individually.
2. Check on the screen that all culture dishes have been removed.
3. Turn off the incubator by pressing the main power switch on the back.

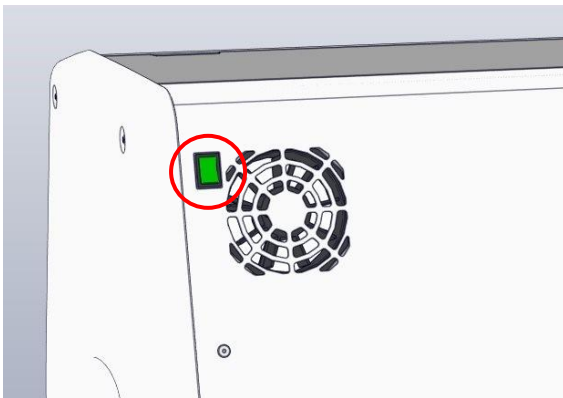

4. Unlock the load door by pressing the emergency unlock button.

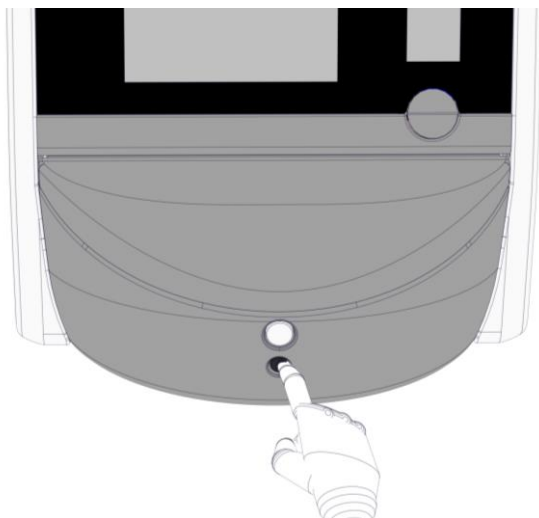

5. Open the load door to the incubation chamber by pressing the white load door open button.
6. Remove the load area frame.

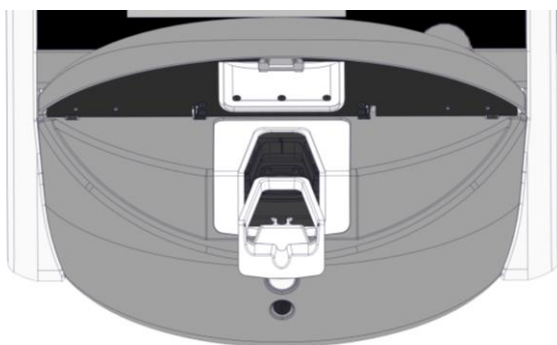

7. Clean all internal surfaces: Apply clean, distilled water to lint-free tissue wipes and wipe all internal surfaces. Repeat until the wipes are no longer discoloured.

8. Use both lint-free tissue wipes and lint-free cotton buds moistened with clean, distilled water to clean the culture dish holder. Repeat until the tissue wipes and cotton buds are no longer discoloured.

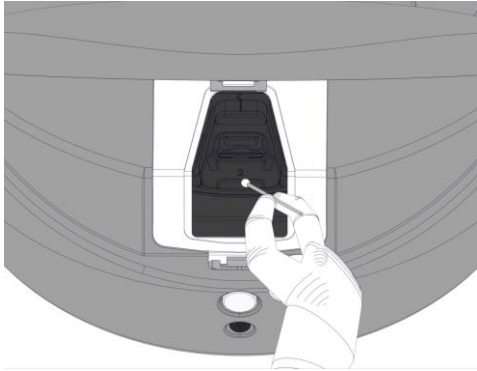

9. Manually rotate the culture dish holder to the next position until all contaminated positions have been cleaned as described in step 8.

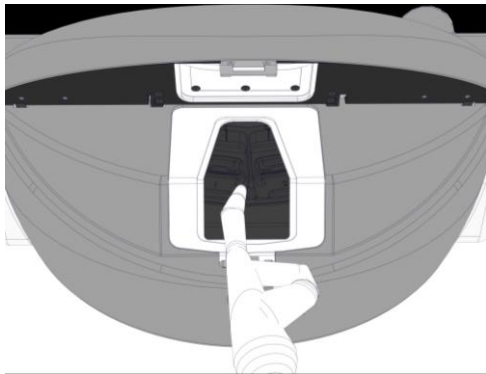

10. Clean the load area frame: Apply clean, distilled water to lint-free tissue wipes and wipe the load area frame. Repeat until the wipes are no longer discoloured.
11. Change gloves and apply a disinfectant that is accordance with laboratory policy to both a lint-free tissue wipe and lint-free cotton buds. Then wipe all surfaces as well as the culture dish holder and load area frame. To do this, follow steps 7 to 10, but use a disinfectant instead of distilled water.
12. After 15 minutes of contact time, apply clean, distilled water to both a lint-free tissue wipe and lint-free cotton buds. Then wipe all surfaces as well as the culture dish holder and load area frame. To do this, repeat steps 7 to 10.
13. Make sure that the load area frame is completely dry and that all traces of the used cleaning agent have evaporated. Then reinsert the load area frame.
14. Inspect the EmbryoScope 8 incubator. If the incubator is visually clean, it is ready for use. If it is not visually clean, go to steps 8 to 13 and repeat the procedure.

15. After completing the cleaning procedure, leave the load door open long enough for all fumes to dissipate (minimum 10 minutes).
16. Turn on the EmbryoScope 8 incubator by pressing the main power switch found on the back.

Allow the incubator three hours to equilibrate gas and temperature levels and for the VOC filter to remove any traces of volatile organic compounds.

6 Changing the VOC HEPA filter

NOTE

- The VOC HEPA filter may be replaced either by a person certified by Vitrolife or by clinic personnel in case the filter needs replacement outside service visits. See section 13.2.3.
- Always use a replacement filter delivered by Vitrolife. This is the only filter that will fit correctly into the quick connectors.

Follow this procedure to replace the VOC HEPA filter:

1. On the PC screen, press the settings icon. Then press **Shutdown** and remove all running culture dishes individually.
2. Check on the screen that all culture dishes have been removed.
3. Turn off the incubator by pressing the main power switch on the back.

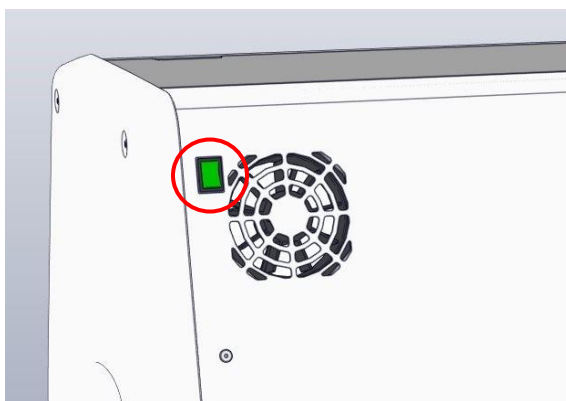

4. Open the service lid at the top of the incubator to access the VOC HEPA filter.

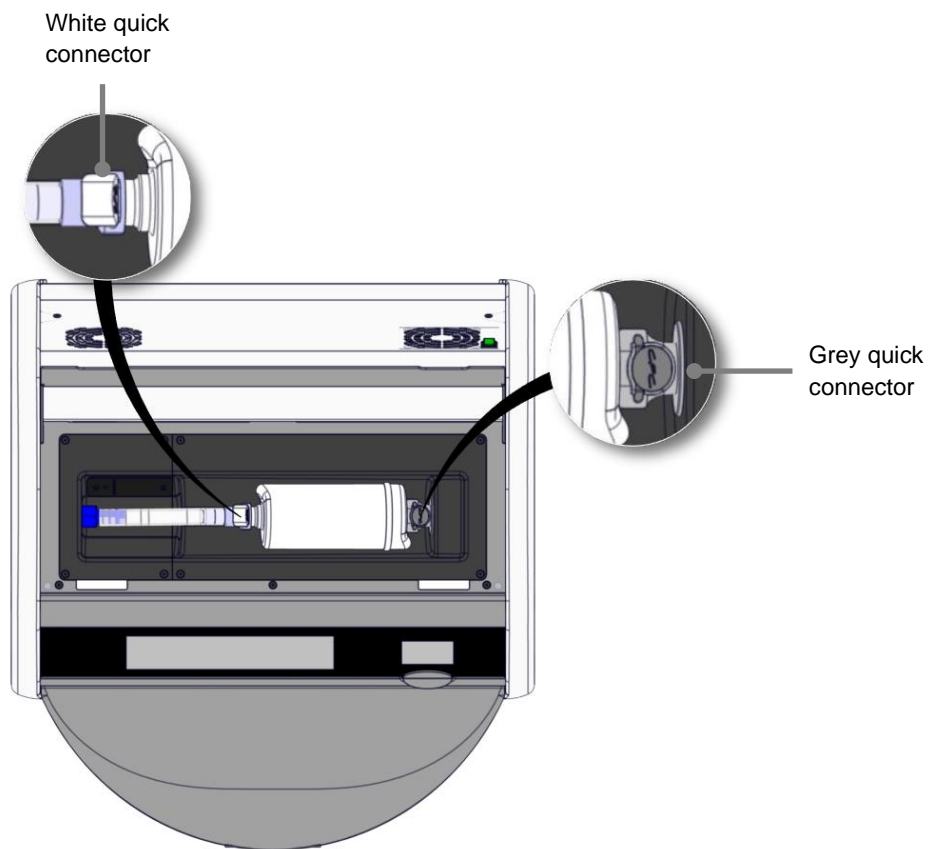

5. To remove the VOC HEPA filter, follow the instructions on the following pages.

a) Press the grey quick connector (mounted in the filter tray), and pull the filter to the left:

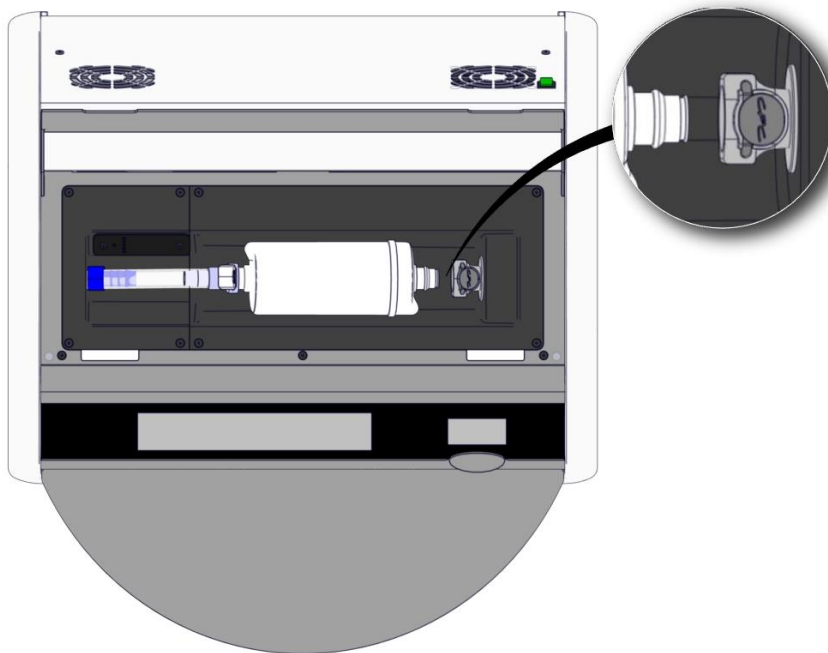
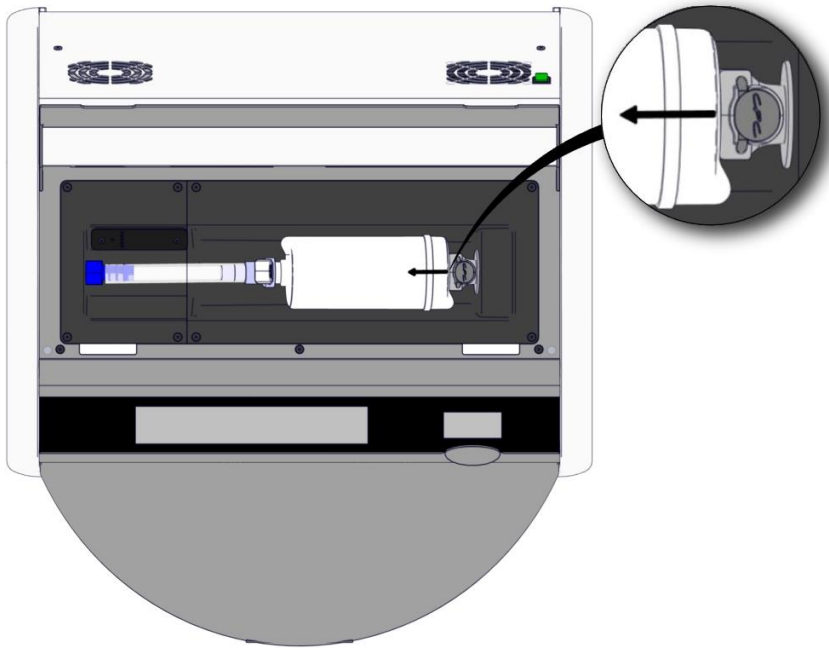

- b) Hold the VOC HEPA filter in upright position, and press the white quick connector while pulling the filter upwards to release it:

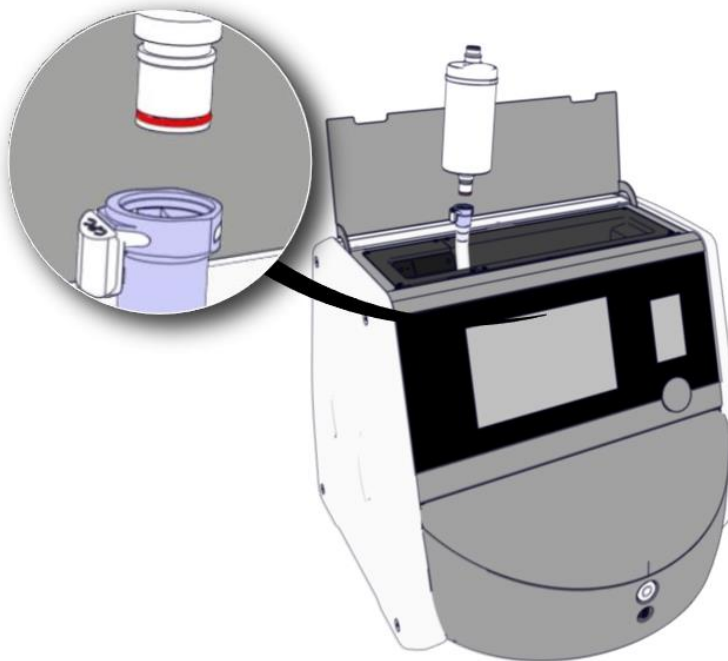
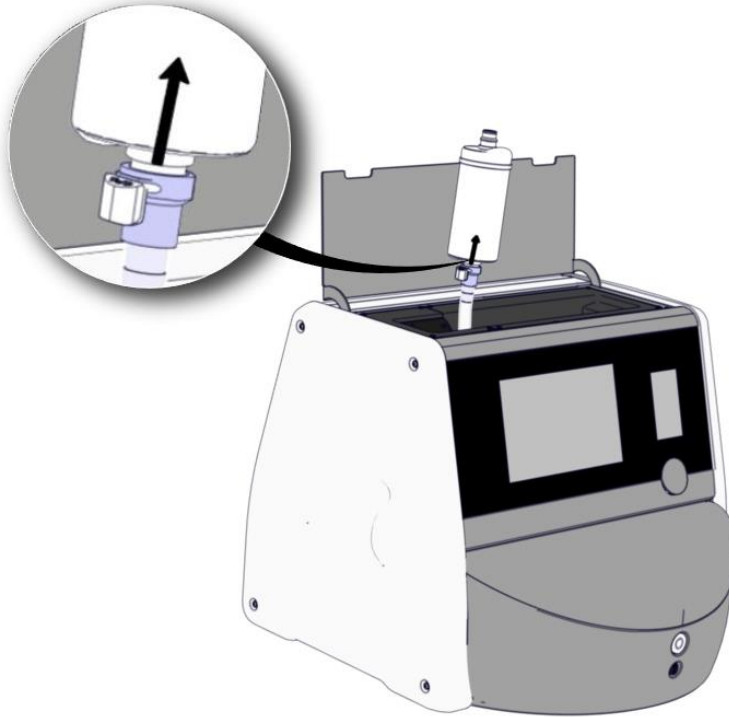

6. Insert a new VOC HEPA filter by reversing the removal procedure:

- a) Insert the end of the VOC HEPA filter that has a red O-ring into the white quick connector:

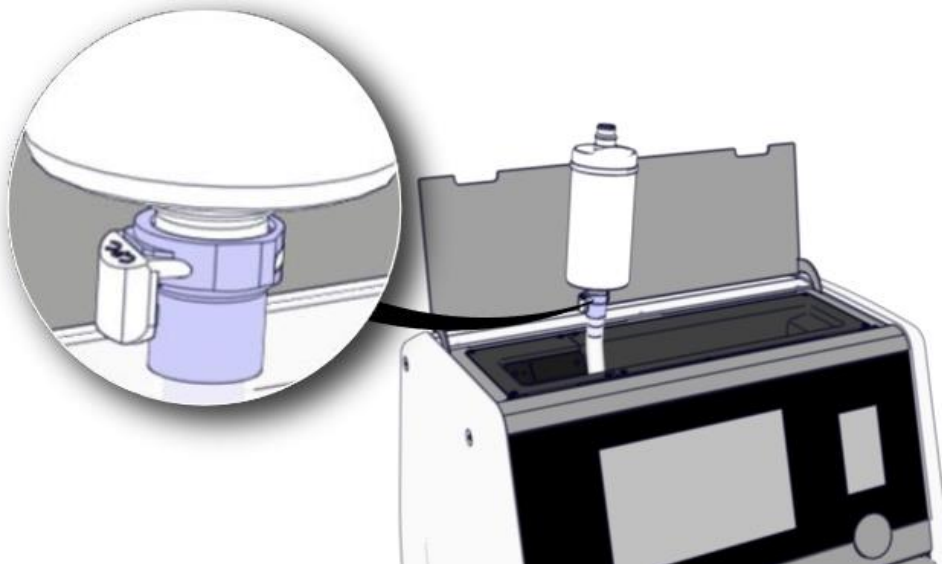
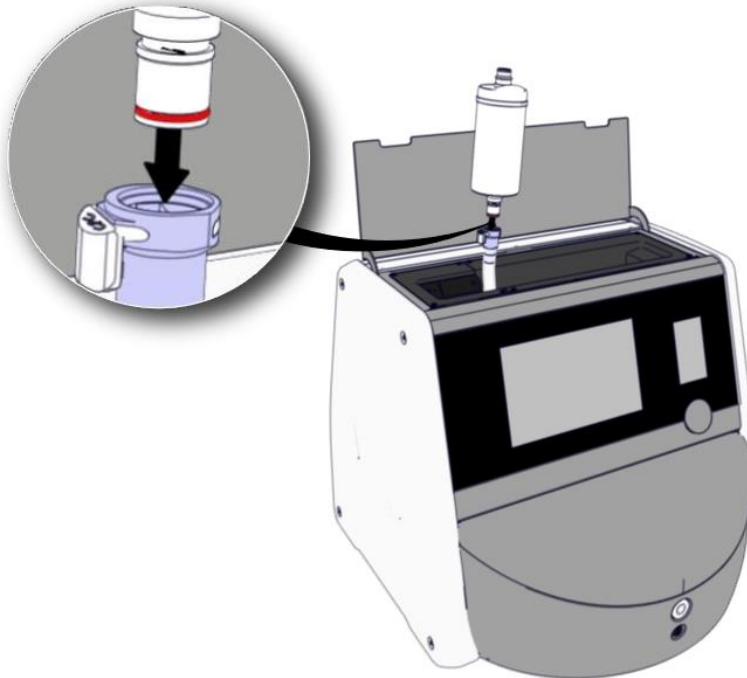

- b) Insert the end of the VOC HEPA filter that has a grey O-ring into the grey quick connector.

Always observe the flow direction indicated on the filter:

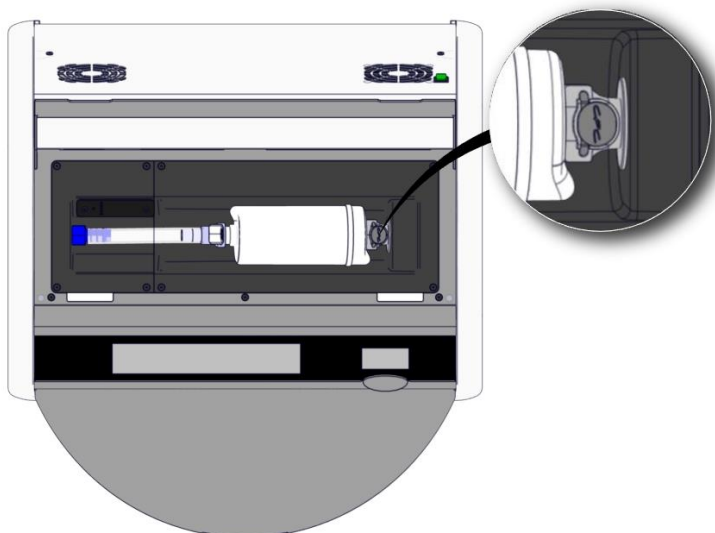
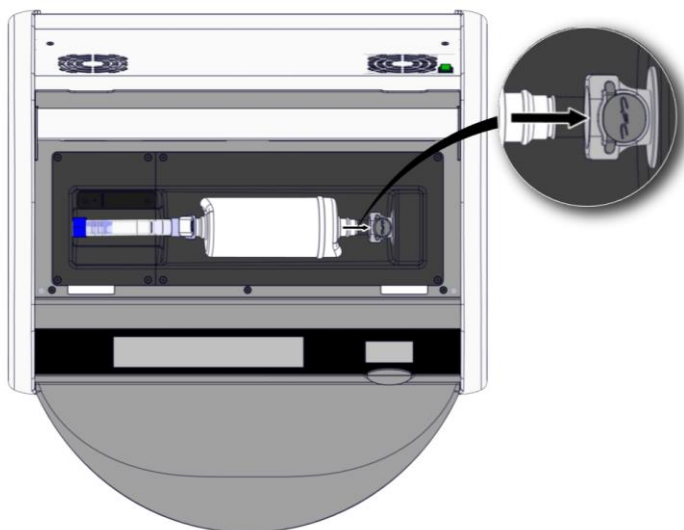

- 7. Turn on the incubator by pressing the main power switch on the back.

7 Replacing the main fuses

WARNING

- Before attempting any of the following, ensure that the main power supply cord is completely detached from the incubator and that all culture dishes have been removed from the incubator.

CAUTION

- Always replace defective main fuses with ones of the specified rating.
- Never attempt to bypass or override the main fuses.

Follow this procedure to replace defective main fuses:

1. Remove all culture dishes from the incubator and place them in a standard incubator by following the emergency procedure described in section 9.
2. Detach the main power supply cord from the inlet at the incubator.
3. Gently open the fuse drawer, which is located directly below the power inlet. For this purpose, use a flathead screwdriver or another small object, and slide the cover forwards until the drawer is fully extended and the fuses become accessible.



Fuse drawer



The drawer is fully extended:

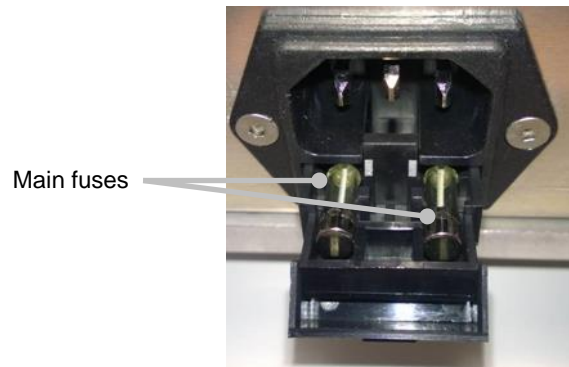

4. Carefully remove both fuses.
You may find it useful to use a small object to gently lift the fuses out of their sockets.
5. Replace the fuses with new ones (2 x T 3.15 A L 250 V).
You cannot insert the replacement fuses in the wrong direction.
6. Close the fuse drawer by gently pushing it back into place.
7. Attach the main power supply cord to the power inlet and switch on the incubator.
8. Re-insert the removed culture dishes after following the start-up procedure described in section 2.3.

NOTE
<ul style="list-style-type: none">• If the main fuses become repeatedly defective, contact Vitrolife support for help.

8 Alarms, warnings and notifications

8.1 Types of alarms, warnings and notifications

8.1.1 Alarms

All alarm conditions are indicated by red visual and/or auditory signals on the incubator. They will also activate an external alarm if the EmbryoScope 8 incubator is connected to an external alarm system (see section 8.10). There may be a delay before the external alarm is activated, depending on the type and severity of the alarm (see section 8.10.2). Most alarms trigger an auditory signal that can be paused for three minutes.

Six types of alarms exist:

- **Temperature alarm**
- **CO₂ concentration alarm**
- **O₂ concentration alarm**
- **O₂ connected to N₂ inlet alarm**

These alarms indicate that the incubation conditions are not as expected. The following conditions are monitored: temperature, CO₂ concentration and O₂ concentration. All alarms are shown on the incubator screen and produce an audible signal that can be paused for three minutes. All alarms activate an external alarm after a defined time delay (see section 8.9).

For a specification of the exact deviations required for the alarm to be activated, see section 10.

- **Incubator malfunction alarm**

An incubator malfunction alarm indicates that there is a system error, i.e. a malfunction or power failure of the unit that controls the incubation conditions. This error has been detected by the Windows PC that controls the image acquisition. Because the incubator system is not functioning properly, it is not possible to activate the auditory alarm controlled by the incubator system itself. Instead, the PC emits an auditory alarm. An alarm message is shown on the PC screen, and the external alarm system is activated.

- **Power failure alarm**

A power failure alarm indicates that the power supply of the incubator has failed. In this case, both screens will turn black and it is not possible to display a visible signal. An audible alarm will sound for 20 seconds before fading away. The fading sound will be audible for up to 10 seconds. The external alarm will also be activated.

8.1.2 Warnings

Warnings are the equivalent of low-priority alarms. Warnings indicate e.g. that the image acquisition has stopped or that the gas supply pressure is too low. All warnings are shown on the incubator screen and produce an audible signal that can be paused for three minutes. All warnings are displayed in red colour, and most of them activate an external alarm after a defined time delay (see section 8.10.2).

Five types of warnings exist:

- **Image acquisition has stopped for more than 60 minutes**
- **Load door has been left open for more than 30 seconds**
- **CO₂ pressure too high/low**
- **O₂ pressure too high/low**
- **Temperature sensor not functioning** (No external alarm or auditory signal. Only one of the redundant temperature sensors is not functioning. Temperature control is handled by the remaining functioning temperature sensor.)

8.1.3 Notifications

Notifications are the equivalent of an information signal. Only one type of notification exists:

- **Lost connection to ES server**

This notification indicates that the connection to the ES server has been temporarily lost. Until the connection is re-established, the image acquisition will continue and the data will be stored on the hard disk of the EmbryoScope 8 incubator. The stored data will automatically be transferred to the ES server when the connection is re-established.

However, until the connection has been re-established and the data transferred:

- Some of the images will be missing on the ES server and thus not available for evaluation in the EmbryoViewer.
- Embryo selections made in the EmbryoViewer will not be updated on the EmbryoScope 8 incubator.
- The barcode function will not be functional. You must manually enter patient information when inserting a culture dish.

8.2 Temporarily pausing alarms

Alarms activate an auditory signal that prompts you to take corrective action. To pause the auditory signal for three minutes, press the pause audio button:



When one of the incubation conditions is not as expected (e.g. deviates from the set point), the button related to that specific condition will be coloured red on the incubator home screen.

Pausing the auditory signal will not affect the colour of the button, which will continue to be pulsating red until the problem has been resolved. The pause audio button will, however, be dimmed while the auditory signal is paused:

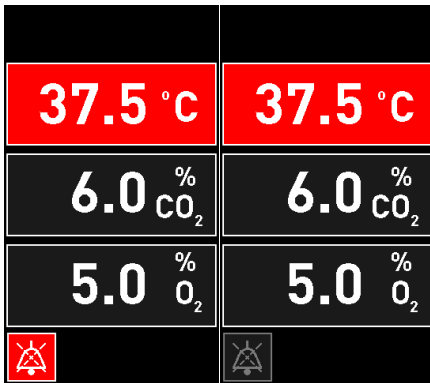

The auditory signal will automatically resume three minutes after it has been paused. This will continue until the problem has been resolved.

It is not possible to adjust set points or change the calibration while one or more alarms are active. Turning the incubator off and back on again will reset all alarms and enable you to adjust the set points during the start-up period. After this period, the alarm will sound again if the condition that caused the alarm has not yet been resolved.

8.3 Overview of the display colours of alarms, warnings and notifications

Alarms, warnings and notifications are displayed with the colour scheme specified below.

8.3.1 Alarms

Active alarms appear in red colour on the incubator home screen. Once the condition that caused the alarm is back within its normal range (i.e. close to the set point), the condition appears in orange colour on the incubator screen. When the alarm has been reset, the display will return to its default black colour.

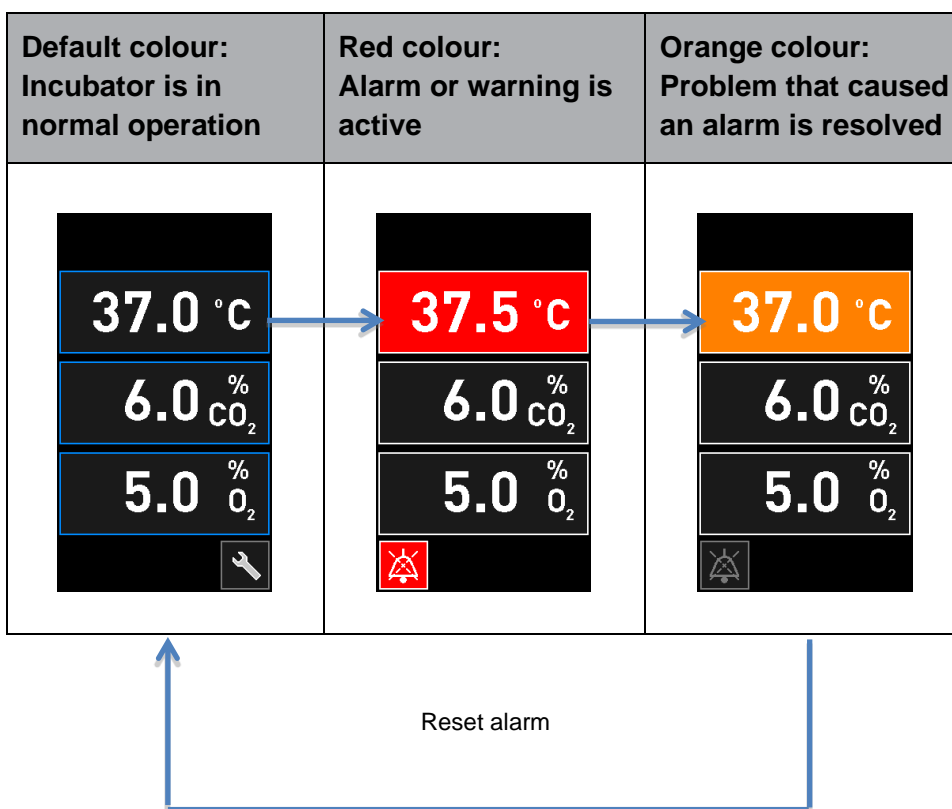

Below is a graphical representation of the alarm colour scheme:



8.3.2 Warnings

Active warnings are shown in red colour on the incubator screen. The warning display alternates with the incubator home screen. When the problem has been resolved, the warning will no longer be displayed and the incubator screen reverts to its default black home screen.

8.3.3 Notifications

Notifications always indicate that the connection to the server has been lost. Such notifications are shown in red colour in the lower left corner of the PC home screen: . Once the problem has been resolved, the notification is no longer active and the screen returns to normal view: .

8.4 Multiple simultaneous alarms

If multiple alarms occur at the same time, the incubator screen will contain several red buttons on the incubator home screen. Both an alarm and a warning may also be active for the same incubation condition, e.g. an alarm related to the CO₂ concentration and a warning related to the CO₂ pressure.

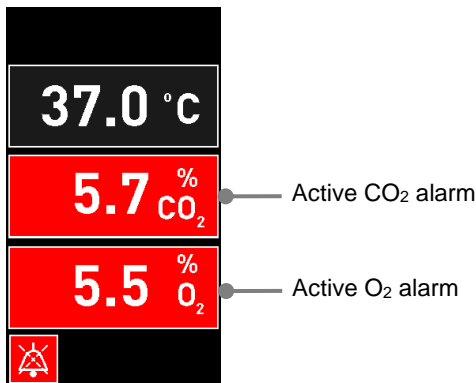

It will not be possible to return to the default incubator home screen, change set points or calibrate the internal sensors until all active alarms have been resolved (displayed in orange colour) and reset.

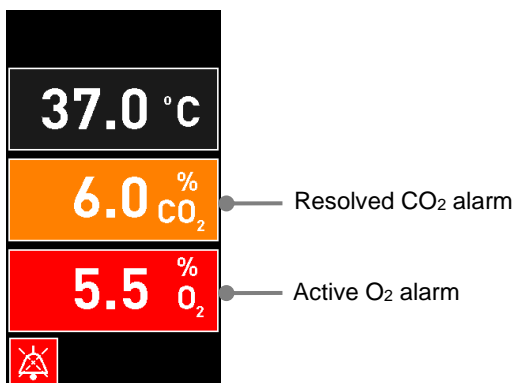

8.5 Resetting alarms

Only resolved alarms related to temperature, CO₂ concentration and O₂ concentration can be reset.

Resolved alarms related to temperature, CO₂ or O₂ must be evaluated and reset in order to return to the default incubator home screen and enable operations such as changing set points or calibrating the sensors.

Only resolved alarms that are no longer active can be reset. These alarms are displayed in orange colour.

To reset a resolved alarm:

1. Press the button for the resolved incubation condition:

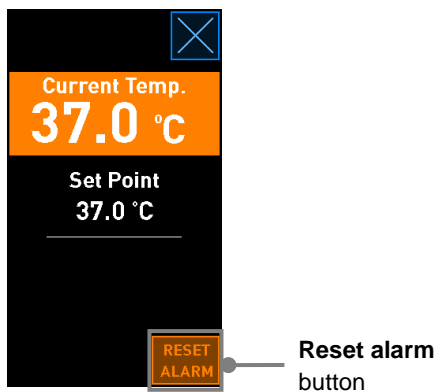

2. Press **Reset alarm**. The incubator home screen is now shown.

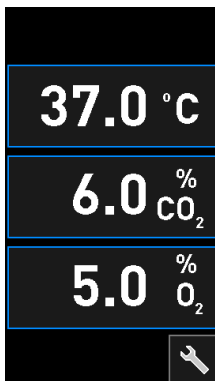

8.6 Graphical overview of alarms and operator response

Alarms are activated when:

- The temperature inside the incubator deviates from its set point
- The CO₂ concentration inside the incubator deviates from its set point
- The O₂ concentration inside the incubator deviates from its set point
- An oxygen bottle was accidentally connected to the nitrogen inlet
- The incubator itself is not functioning correctly (malfunction)
- The power to the incubator has been cut off.

For a specification of the exact deviations required for the alarm to be activated, see section 10.

On the following pages, you find an overview of all alarms and the required operator response.

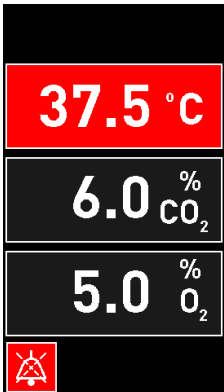
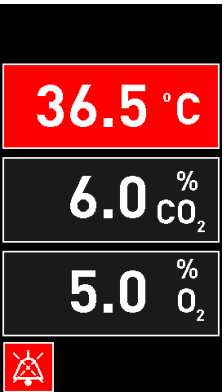
TEMPERATURE		
Error condition 1	Error condition 2	Operator response
Temperature is too high: 	Temperature is too low: 	If the error condition cannot be immediately resolved, turn off the EmbryoScope 8 incubator from the main power switch located on the back of the incubator. Then remove all culture dishes by following the emergency procedure described in section 9.

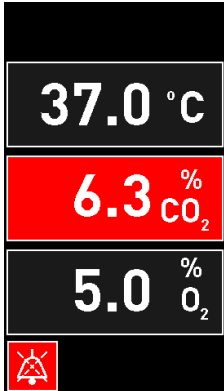
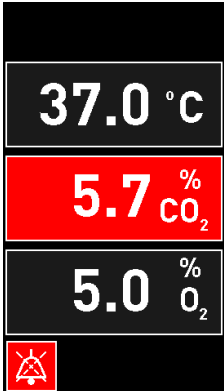
CO ₂ CONCENTRATION		
Error condition 1	Error condition 2	Operator response
CO ₂ concentration is too high: 	CO ₂ concentration is too low: 	If the error condition cannot be immediately resolved, shut down the EmbryoScope 8 incubator from the PC home screen -> Settings screen -> Shutdown button. Then remove all culture dishes by following the instructions on the screen.

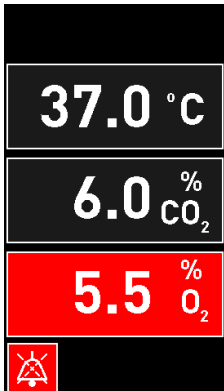
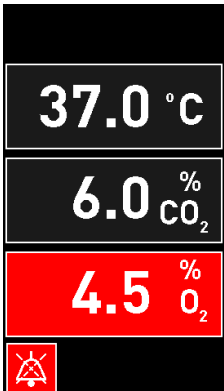
O ₂ CONCENTRATION		
Error condition 1	Error condition 2	Operator response
O ₂ concentration is too high: 	O ₂ concentration is too low: 	If the error condition cannot be immediately resolved, shut down the EmbryoScope 8 incubator from the PC home screen -> Settings screen -> Shutdown button. Then remove all culture dishes by following the instructions on the screen.

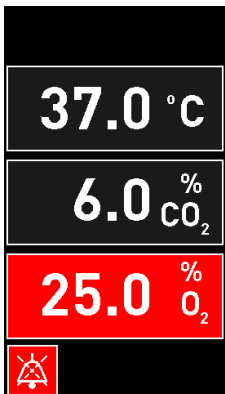
GAS CONNECTION		
Error condition 1	Error condition 2	Operator response
<p>If an oxygen bottle is accidentally connected to the nitrogen inlet, an O₂ high alarm will be activated when the O₂ concentration reaches 25%:</p> 	N/A	<p>If the error condition cannot be immediately resolved, turn off the EmbryoScope 8 incubator from the main power switch located on the back of the incubator. Then remove all culture dishes by following the emergency procedure described in section 9.</p>

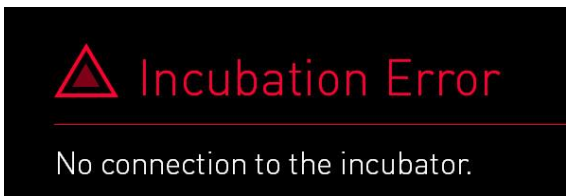
INCUBATOR MALFUNCTION		
Error condition 1	Error condition 2	Operator response
<p>Incubator is not functioning correctly:</p> 	N/A	<p>If an incubator malfunction alarm has been activated, turn off the EmbryoScope 8 incubator from the main power switch located on the back of the incubator. Then remove all culture dishes by following the emergency procedure described in section 9.</p>

POWER FAILURE		
Error condition 1	Error condition 2	Operator response
<p>The power to the incubator has been cut off.</p> <p>It is not possible to display a visible alarm signal. For this type of alarm, there will only be an auditory signal that slowly fades away.</p>	N/A	<p>If there is a complete power failure, turn off the EmbryoScope 8 incubator from the main switch located at the back of the cabinet. Then remove all culture dishes by following the emergency procedure described in section 9.</p>

8.7 Graphical overview of warnings and operator response

A warning is activated when:

- The CO₂/N₂ pressure in a connected gas tube is too low
- The image acquisition has stopped
- The load door has been left open for more than 30 seconds
- One of the temperature sensors is not functioning correctly.

For a specification of the exact deviations required for a warning to be issued, see section 10.

On the following pages, you find a graphical overview of possible warnings and the required operator response.



INLET PRESSURE		
Error condition 1	Error condition 2	Operator response
<p>CO₂ inlet pressure is too low:</p> 	<p>N₂ inlet pressure is too low:</p> 	<p>Check gas cylinders and supply lines to ensure adequate supply of gas at the required pressure (see specifications).</p>

IMAGE ACQUISITION STOPPED		
Error condition 1	Error condition 2	Operator response
<p>The image acquisition has stopped due to unforeseen circumstances:</p>  <p>The display alternates with the default incubator home screen so that the incubation conditions are always visible to the operator.</p>	N/A	<p>Follow the instructions on the screen.</p> <p>If the problem persists, call Vitrolife support.</p>

LOAD DOOR OPEN		
Error condition 1	Error condition 2	Operator response
<p>The load door has been left open for more than 30 seconds:</p> 	N/A	<p>Close the load door.</p>

TEMPERATURE SENSOR ERROR		
Error condition 1	Error condition 2	Operator response
<p>One of the temperature sensors is not functioning properly. The other temperature sensor is still functioning correctly and controls the temperature in the microwell:</p> 	N/A	Call Vitrolife support.

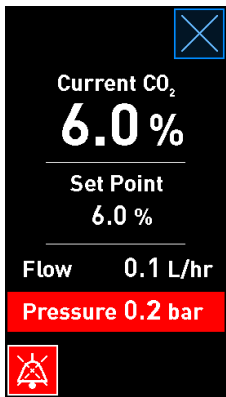
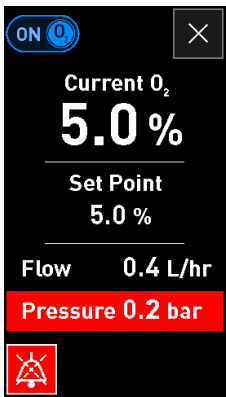
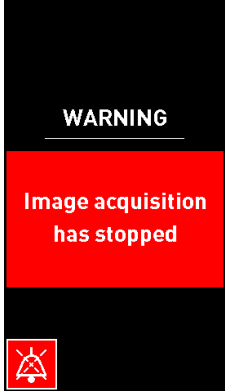
8.8 Graphical overview of notifications and operator response

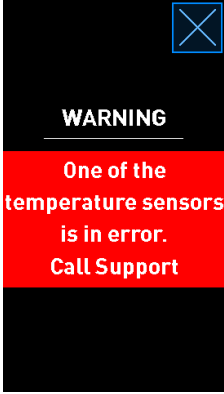
A notification occurs when:

- The connection to the ES server has been lost.

Below is a graphical representation of the notification and the required operator response.

LOST CONNECTION TO THE ES SERVER		
Error condition 1	Error condition 2	Operator response
<p>The connection to the ES server has been lost:</p> 	N/A	Re-establish the connection to the ES server. If this is not possible, call Vitrolife support.

8.9 Overview of error conditions and control unit responses

Error condition	Visual warning			Auditory signal			Delay (visual and auditory)	External alarm		"Resolved" indication
	Colour of signal	Incubator screen	PC screen	Incubator sound (can be paused)	Power failure sound (fades away after 20 seconds)	PC sound	Delay (minutes)	External alarm activated	Additional delay (minutes)	Indication that alarm has occurred and been resolved (orange on incubator screen)
Alarm: Temperature ¹	Red	YES	Details	YES	-	-	0	YES	2	YES
Alarm: CO ₂ concentration ¹	Red	YES	Details	YES	-	-	0 or 5 ²	YES	2	YES
Alarm: O ₂ concentration ¹	Red	YES	Details	YES	-	-	0 or 5 ²	YES	2	YES
Alarm: O ₂ connected to N ₂	Red	YES	Details	YES	-	-	0	YES	2	YES
Alarm: Incubator malfunction	See 8.6	-	Details	-	-	YES	0.5	YES	0	-
Alarm: Power failure	-	-	-	-	YES	-	0	YES	0	-
Warning: Image acquisition stopped	Red	YES	Details	YES	-	-	Less than 60 min.	YES	2	-
Warning: Load door open	Red	YES	Details	YES	-	-	0.5	YES	2	-
Warning: CO ₂ pressure	Red	YES	Details	YES	-	-	3	YES	2	-
Warning: N ₂ pressure	Red	YES	Details	YES	-	-	3	YES	2	-
Warning: Temperature sensor	Red	YES	Details	NO	-	-	Repeated after 12 hrs.	NO	-	-
Notification: No connection to the ES server	See 8.8	-	Details	-	-	-	-	-	-	-

¹ During the first 30 minutes after a system start-up, no temperature or gas concentration alarms will be activated.

² The auditory signal will normally sound without any delay. However, the alarms are deactivated for five minutes after door openings to allow the incubation conditions to recover. After calibration or set point adjustments, the delay will be one minute. During validation, there will be no signal.

8.10 External alarm system

The integrated alarm system in the EmbryoScope 8 incubator can be connected to an external alarm system through a plug that is located on the back of the incubator. The alarm signal of the EmbryoScope 8 incubator can be detected by most commercial external alarm systems that can notify users by phone, pager, SMS or e-mail. This will provide enhanced 24-hour monitoring of critical incubation conditions such as temperature and gas concentrations.

8.10.1 Overview of errors sent to the external alarm system

The external alarm system will only be activated when a number of pre-defined errors occur (see activation delays in section 8.10.2). Below is a list of the errors that will activate the external alarm system.

Errors that are not included in this list will not set off the external alarm.

Alarms:

- Temperature alarms
- CO₂ concentration alarms
- O₂ concentration alarms
- O₂ connected to N₂ inlet alarms
- Incubator malfunction alarms
- Power failure alarms.

Warnings:

- Image acquisition stopped
- Load door open
- CO₂ pressure warning
- O₂ pressure warning.

See sections 8.1.1 and 8.1.2 for an overview of the alarms and warnings that will set off the external alarm.

8.10.2 Delay of external alarms and warnings

In most cases when an error condition has occurred, there will be a time delay before the external alarm is activated. This prevents the external alarm system from being falsely or prematurely activated during normal operation.

Prior to being sent out externally, the alarms will appear either on the PC screen or on the incubator screen of the incubator itself. This e.g. means that temperature alarms will be activated immediately on the incubator itself.

See section 10 for information on when the various alarms, warnings and notifications are activated on the incubator itself.

For each type of error condition that may occur, the table in section 8.9 specifies the total length of the delay until each type of error is sent to the external alarm system.

8.10.3 Connecting the external alarm

The information contained in this section is primarily intended for technical staff members who are tasked with setting up the EmbryoScope 8 incubator with an external alarm.

The four-pin alarm plug is labelled *Alarm* and placed on the back of the EmbryoScope 8 incubator (see section 3).

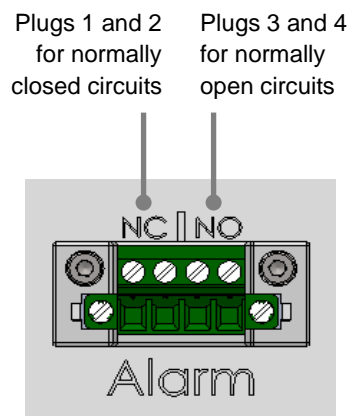

The EmbryoScope 8 incubator supports two types of circuits: normally closed or normally open. The connected external alarm system should match the chosen circuit.

It is up to the clinic's preferences which type of circuit to use.

9 Emergency procedure

The emergency procedure is also found under the service lid.

9.1 Removing culture dishes after a system failure

The safest way to terminate all culture dishes is described in section 4.2.1.5. However, in case of an emergency, all culture dishes can be terminated immediately by performing the following actions.

NOTE

- The emergency procedure may only be used when all other options to safeguard the running culture dishes have failed.

1. Turn off the EmbryoScope 8 incubator on the main power switch.

The main power switch is the illuminated green switch on the back, upper left corner.

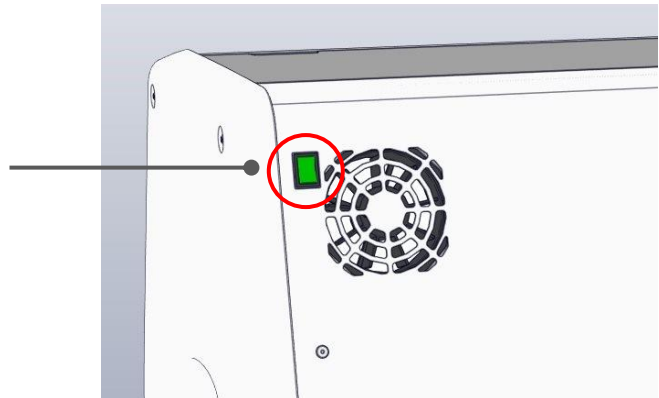

2. Press the emergency unlock button at the front to unlock the load door. Then press the white load door open button.

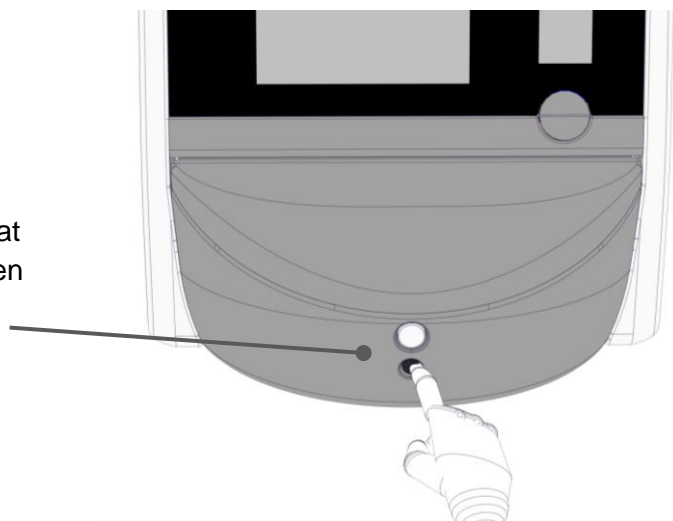

3. Remove the load area frame.

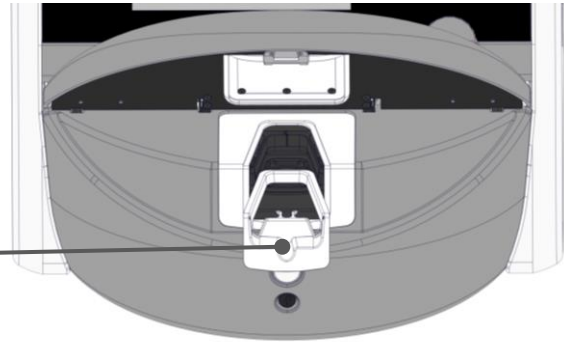

4. Manually rotate the culture dish holder clockwise until a culture dish appears. Then remove the culture dish and place it in another incubator.

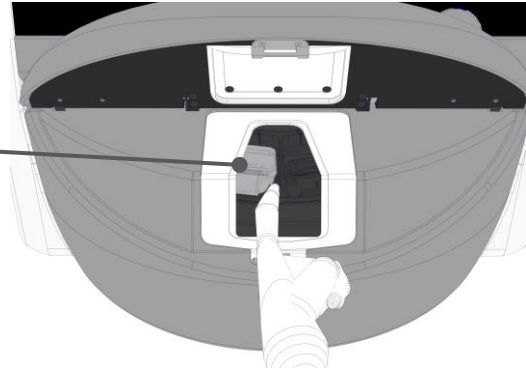

5. Remove the rest of the culture dishes by rotating the culture dish holder again and removing the next dish. Repeat as many times as possible until you reach a hard stop. Then rotate the holder counter-clockwise as many times as possible until you reach a hard stop.

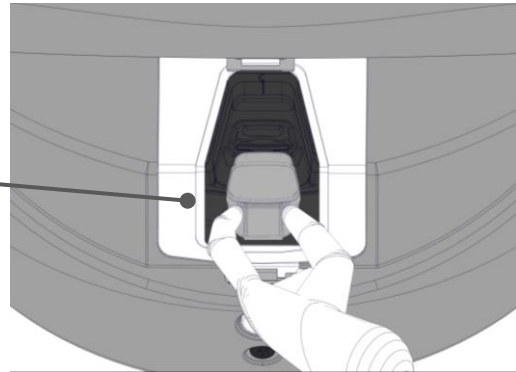

6. Double-check that ALL culture dishes have been removed by repeating step 5.

7. Call Vitrolife support:

Europe, Middle East and Africa: +45 7023 0500

Americas: +1 888-879-9092

Japan and Pacific: +81(0)3-6459-4437

Asia: +86 10 6403 6613

10 Technical specifications

Additional information on the specifications is found under the respective sections in this manual.

Incubator:

- Capacity: 8 culture dishes containing 16 (EmbryoSlide+) or 8 (EmbryoSlide+ ic8) embryos each, i.e. up to 128 embryos in total.
- Temperature range: 36°C – 39°C. The temperature set point can be adjusted in steps of 0.1°C.
- Temperature accuracy during incubation: +/- 0.2°C.
- CO₂ range:
 - 3% – 8% (incubators with serial numbers below 4343).
 - 3% – 12% (incubators with serial numbers 4343 and above).The CO₂ set point can be adjusted in steps of 0.1%.
- CO₂ accuracy: +/- 0.3%.
- O₂ range: 4% – 8% (with O₂ regulation) or ambient (without O₂ regulation). The O₂ set point can be adjusted in steps of 0.1%.
- O₂ accuracy: +/- 0.5%.
- Accuracy of displayed values: 0.1%, 0.1°C, 0.1 bar.

Alarms, warnings and notifications:

- **Alarms (high-priority alarms communicated to the external alarm system):**
 - **Temperature alarm:** Immediately displayed on the incubator screen when the temperature deviates by +/- 0.2°C from the set point.

After the initial start-up of the incubator, there will be a grace period of 30 minutes before the temperature alarm is issued.
 - **CO₂ concentration alarm:** Immediately displayed on the incubator screen when the CO₂ concentration deviates by +/- 0.3% from the set point.

After load door openings, there will be a grace period of 5 minutes before the CO₂ concentration alarm is issued.

After the initial start-up of the incubator, there will be a grace period of 30 minutes before the CO₂ concentration alarm is issued.
 - **O₂ concentration alarm:** Immediately displayed on the incubator screen when the O₂ concentration deviates by +/- 0.5% from the set point.

After load door openings, there will be a grace period of 5 minutes before the O₂ concentration alarm is issued.

After the initial start-up of the incubator, there will be a grace period of 30 minutes before the O₂ concentration alarm is issued.

- **O₂ connected to N₂ alarm:** Displayed on the incubator screen when an oxygen bottle is accidentally connected to the nitrogen inlet and the O₂ concentration therefore exceeds 25%.
- **Malfunction of the unit that controls the running conditions of the EmbryoScope 8 incubator**
- **Power failure of the entire incubator**
- **Warnings** (low-priority alarms communicated to the external alarm system):
 - **Image acquisition warning:** Image acquisition has stopped. The external alarm system will be activated within 60 minutes. The exact delay depends on the specific situation.
 - **Load door warning:** Load door has been left open for more than 30 seconds.
 - **CO₂ pressure warning:** Displayed on the incubator screen after 3 minutes when the CO₂ pressure is less than 0.2 bar.
 - **N₂ pressure warning:** Displayed on the incubator screen after 3 minutes when the N₂ pressure is less than 0.2 bar.
 - **Temperature sensor warning:** Displayed on the incubator screen when one of the temperature sensors is not functioning correctly (does *not* activate the external alarm or produce any auditory signal).
- **Notification** (*not* communicated to the external alarm system):
 - No connection to the ES server.

Air flow:

- Recirculation: > 100 l/h (full VOC HEPA filtration of gas volume every 6 minutes).
- VOC HEPA filter retains 99.97% particles > 0.3 µm.
- Active carbon filter to retain volatile organic compounds (VOC).

Embryo images:

- Images are acquired in 2048 x 1088 pixels (2.2 MP) with a 12-bit monochrome CMOS camera.
- Custom-made, high-quality 16x, 0.50 N.A. LWD Hoffman Modulation Contrast objective providing a resolution of 3 pixels per μm .
- Illumination: single red LED (627 nm, duration \leq 0.02 seconds per image).
- Total light exposure time: < 40 seconds per day per embryo.
- Time between image acquisitions: 10 minutes' cycle time.

Other information:

- Power supply voltage: 230 VAC.
- Power supply frequency: 50 Hz – 60 Hz.
- Maximum power consumption: 250 VA.
- Typical power consumption: 95 VA.
- Gas requirements: medical grade CO₂.
- Optional gas: medical grade N₂.
- Maximum N₂ consumption: 5 l/h. Typical consumption: 2 l/h to 3 l/h.
- Maximum CO₂ consumption: 2 l/h. Typical consumption: 0.5 l/h.
- Dimensions (W x D x H): 55 x 60 x 50 cm.
- Weight: 50 kg.
- The IP rating of the incubator is IPX0: non-protected against ingress of water.
- Mains power cable: maximum 3 metres, minimum 250 VAC, minimum 10 A.

List of cables and their maximum length:

Name	Category	Type	Maximum length
External alarm	Signal	Unshielded	25 metres
AC mains	AC power	Unshielded	3 metres
Ethernet (CAT6)	Telecom	Shielded	30 metres
External logging system	Signal	Unshielded	30 metres

Isolation of poles:

- Isolation of all poles simultaneously is achieved by either turning off the EmbryoScope 8 incubator by using the main power switch at the back of the incubator or by unplugging the power supply cord from the power supply socket.

Installation:

- Installation and service (corrective and planned) of the EmbryoScope 8 incubator may only be carried out by a person certified by Vitrolife. Installation instructions are available in the manual entitled *Planned service and maintenance* (English only).

Environmental conditions during operation:

- Ambient temperature: 20°C to 28°C.
- Relative humidity: 0% to 85%.
- Operating altitude:
 - < 2,000 m above sea level (incubators with serial numbers below 4343).
 - < 3,000 m above sea level (incubators with serial numbers 4343 and above).

Environmental conditions during storage and transportation:

- Temperature: -10°C to +50°C.
- Relative humidity: 30% to 80%.

When received, all shipping boxes should be inspected for signs of damage during transportation. In case the boxes are damaged, contact Vitrolife immediately for further instructions. Do NOT open the boxes. Leave the EmbryoScope 8 incubator in the shipping boxes in a dry and safe place until it can be handled by a person certified by Vitrolife.

Behaviour in case EMC immunity test levels are exceeded:

If the incubator is subjected to EMC immunity levels exceeding the levels tested, malfunctions and instabilities may occur, e.g. alarms and screen flickering.

Fuses:

Fuse ID	Breaking capacity	Operating speed and current	Temperature	Minimum voltage (AC)	Component	Littelfuse part no.
FH1	10 kA/ 125 VAC	Medium 1 A	N/A	125 V	Door lock	0233 001
FH2	10 kA/ 125 VAC	Medium T2 A	N/A	125 V	Motors	0233 002
FH3	10 kA/ 125 VAC	Medium T5 A	N/A	125 V	Incubator 24 V	0233 005
FH4	10 kA/ 125 VAC	Medium T2 A	N/A	125 V	Incubator 12 V	0233 002
FH5	10 kA/ 125 VAC	Medium 2.5 A	N/A	125 V	PC	0233 02.5
FH6	10 kA/ 125 VAC	Medium 2.5 A	N/A	125 V	Internal 12 V	0233 02.5
Thermal fuse	8 A Inductive	N/A	72°C	250 V	Complete unit	Thermodisc G4A01072C
Main fuses	35 A/ 250 VAC	Slow 3.15 A	N/A	250 V	Complete unit	0213315MXP

11 EMC and HF technical review

Medical electrical equipment needs special precautions regarding EMC and must be installed and put into service according to the EMC specifications provided in this section.

WARNING

- The use of accessories, transducers and cables other than those specified, with the exemption of transducers and cables sold by the manufacturer of the system as replacement parts for internal components, may result in increased emissions or decreased immunity of the equipment or system.
- The EmbryoScope 8 incubator should not be used adjacent to or stacked with other equipment. If adjacent or stacked use is necessary, the incubator should be observed to verify normal operation in the configuration in which it will be used.

11.1 Electromagnetic emissions

The below table contains the applicable information required for CISPR11 systems:

Guidance and manufacturer's declaration – electromagnetic emissions

The EmbryoScope 8 incubator is intended for use in the home healthcare environment specified below. The customer or the user of the EmbryoScope 8 incubator should assure that it is used in such an environment.

Emissions test	Compliance	Electromagnetic environment – guidance
Conducted emission EN/CISPR 11:2010	Group 1	<p>The EmbryoScope 8 incubator uses RF energy only for its internal function. Therefore, its RF emissions are very low and not likely to cause any interference in nearby electronic equipment.</p> <p>The EmbryoScope 8 incubator is suitable for use in all establishments, including domestic establishments and those directly connected to the public low-voltage power supply network that supplies buildings used for domestic purposes.</p>
RF emission EN/CISPR 11:2010	Class B	
Harmonic emission IEC 61000-3-2:2009	Class A	
Voltage fluctuation (flicker emission) IEC 61000-3-3:2013	Complies	

11.2 Electromagnetic immunity

Guidance and manufacturer's declaration – electromagnetic immunity The EmbryoScope 8 incubator is intended for use in the home healthcare environment specified below. The customer or the user of the EmbryoScope 8 incubator should assure that it is used in such an environment.			
Immunity test	IEC 60601 test level	Compliance level	Electromagnetic environment – guidance
Electrostatic discharge (ESD) IEC 61000-4-2	± 8 kV contact ± 2 kV, ± 4 kV, ± 8 kV, ± 15 kV air	± 8 kV contact ± 2 kV, ± 4 kV, ± 8 kV, ± 15 kV air	Floors should be wood, concrete or ceramic tile. If floors are covered with synthetic material, the relative humidity should be at least 30%.
Electrical fast transient/burst IEC 61000-4-4:2012	± 2 kV for power supply lines ± 1 kV for input/output lines	± 2 kV for power supply lines ± 1 kV for input/output lines	Mains power quality should be that of a typical commercial or hospital environment.
Surges IEC 61000-4-5:2005	± 0,5 kV, ± 1 kV line-to-line ± 0,5 kV, ± 1 kV, ± 2 kV line-to-ground	± 0,5 kV, ± 1 kV line-to-line ± 0,5 kV, ± 1 kV, ± 2 kV line-to-ground	Mains power quality should be that of a typical commercial or hospital environment.
Voltage dips, short interruptions and voltage variations on power supply input lines IEC 61000-4-11:2004	EUT: Reduction of input voltage to 0% for 0.5 cycles @ 0°, 45°, 90°, 135°, 180°, 225°, 270° and 315°	Result: PASS: No change in operation. The system remained safe.	Mains power quality should be that of a typical commercial or hospital environment. If the user of the EmbryoScope 8 incubator requires continued operation during mains power interruptions, it is recommended that the incubator be powered from an uninterruptible power supply or battery. EUT remained safe during the test.
	Reduction of input voltage to 0% for 1 cycle @ 0°	PASS: No change in operation. The system remained safe.	
	Reduction of input voltage to 70% for 30 cycles @ 0°	PASS: No change in operation. The system remained safe.	
	Reduction of input voltage to 0% for 300 cycles	PASS: The system is allowed to turn off as long as it establishes normal operation after the test.	
Power frequency (50/60 Hz) magnetic fields IEC 61000-4-8:2009	30 A/m	30 A/m PASS: No change in operation. The system remained safe.	Power frequency magnetic fields should be at levels characteristic of a typical commercial or hospital environment.

The two tables below contain the applicable information required for a system other than those specified for use only in a shielded location and for systems that are not life-supporting.

Guidance and manufacturer's declaration – electromagnetic immunity			
The EmbryoScope 8 incubator is intended for use in the home healthcare environment specified below. The customer or the user of the EmbryoScope 8 incubator should assure that it is used in such an environment.			
Immunity test	IEC 60601 test level	Compliance level	Electromagnetic environment – guidance
Conducted RF IEC 61000-4-6:2013	3 Vrms 150 kHz to 80 MHz 6 Vrms in ISM and amateur radio bands between 150 kHz to 80 MHz	3 Vrms 150 kHz to 80 MHz 6 Vrms in ISM and amateur radio bands between 150 kHz to 80 MHz	EUT remained safe during the test in normal operational mode and in alarm mode. It is recommended that portable and mobile RF communications equipment is used no closer to any part of the EmbryoScope 8 incubator, including cables, than 0.3 metres, which corresponds to the distance of the test level applied. Otherwise, degradation of the performance of the EmbryoScope 8 incubator could result.
Radiated RF IEC 61000-4-3:2006 + A1:2007 + A2:2010	10 V/m 80 MHz to 2.7 GHz	10 V/m 80 MHz to 2.7 GHz	
Radiated RF IEC 61000-4-3:2006 + A1:2007 + A2:2010 – Proximity fields from RF wireless communications equipment	TETRA 400	385 MHz, PM, 18 Hz, 1.8 W, 27 V/m	
	GMRS 460 FRS 460	450 MHz, FM, ± 5 kHz dev, 1 kHz sine, 2 W, 28 V/m	
	LTE Band 13 LTE Band 17	710/745/780 MHz, PM, 217 Hz, 0.2 W, 9 V/m	
	GSM 800 GSM 900 TETRA 800 iDEN 820 CDMA 850 LTE Band 5	810/870/930 MHz, PM, 18 Hz, 2 W, 28 V/m	
	GSM 1800 CDMA 1900 GSM 1900 DECT LTE Band 1 LTE Band 3 LTE Band 4 LTE Band 25	1720/1845/1970 MHz, PM, 217 Hz, 2 W, 28 V/m	

Guidance and manufacturer's declaration – electromagnetic immunity

The EmbryoScope 8 incubator is intended for use in the home healthcare environment specified below. The customer or the user of the EmbryoScope 8 incubator should assure that it is used in such an environment.

Immunity test		IEC 60601 test level	Compliance level	Electromagnetic environment – guidance
Bluetooth	WLAN 802.11 b	2450 MHz, PM, 217 Hz, 2 W, 28 V/m	2450 MHz, PM, 217 Hz, 2 W, 28 V/m	
	WLAN 802.11 g			
	WLAN 802.11 n			
	RFID 2450			
	LTE Band 7			
	WLAN 802.11 a	5240/5500/5785 MHz, PM, 217 Hz, 0.2 W, 9 V/m	5240/5500/5785 MHz, PM, 217 Hz, 0.2 W, 9 V/m	
	WLAN 802.11 n			

NOTE 1 At 80 MHz and 800 MHz, the higher frequency range applies.

NOTE 2 These guidelines may not apply in all situations. Electromagnetic propagation is affected by absorption and reflection from structures, objects and people.

1 Field strengths from fixed transmitters, such as base stations for radio (cellular/cordless) telephones and land mobile radios, amateur radio, AM and FM radio broadcast and TV broadcast, cannot be predicted theoretically with accuracy. To assess the electromagnetic environment due to fixed transmitters, an electromagnetic site survey should be considered. If the measured field strength in the location in which the EmbryoScope 8 incubator is used exceeds the applicable RF compliance level above, the EmbryoScope 8 incubator should be observed to verify normal operation. If abnormal performance is observed, additional measures may be necessary, such as reorienting or relocating the incubator.

Recommended separation distances between portable and mobile RF communications equipment and the EmbryoScope 8 incubator

The EmbryoScope 8 incubator is intended for use in a home healthcare environment in which radiated RF disturbances are controlled. The customer or the user of the EmbryoScope 8 incubator can help prevent electromagnetic interference by maintaining a minimum distance between portable RF communications equipment (transmitters) and the EmbryoScope 8 system as recommended below, according to the maximum output power of the communications equipment.

Rated maximum output power (P) of transmitter [W]	Minimum separation distance (d) according to frequency of transmitter [m]	
	@ Immunity test level (E) 3 V/m, 0.15-80 MHz	@ Immunity test (E) 10 V/m, 80-2700 MHz
0.06	0.49	0.15
0.12	0.69	0.21
0.25	1.00	0.30
0.5	1.41	0.42
1	2.00	0.60
2	2.83	0.85

Calculation: $d = \frac{6 * \sqrt{P}}{E}$

For transmitters rated at a maximum output power not listed above, the recommended separation distance (d) in metres (m) can be estimated using the equation applicable to the frequency of the transmitter, where P is the maximum output power rating of the transmitter in watts (W) according to the transmitter manufacturer.

At 80 MHz, the separation distance for the higher frequency applies.

These guidelines may not apply in all situations. Electromagnetic propagation is affected by absorption and reflection from structures, objects and people.

12 Accessories and materials

The following equipment and materials are needed to run the EmbryoScope 8 incubator:

- Culture dishes (refer to the user manual for the culture dishes)
- EmbryoViewer
- Lint-free cotton buds (see section 5)
- Lint-free tissue wipes
- Aqueous 70% ethanol (see section 5.1)
- A disinfectant that is in accordance with laboratory policy (see section 5.2)
- A high-precision thermometer connected to a probe (see section 4.1.3)
- A gas analyser (see section 4.1.5.2)
- Access to CO₂ (medical grade)
- Optional: access to N₂ (medical grade).

The thermometer and gas analyser used when calibrating the incubator should be as least as accurate as the values displayed on the incubator itself or better, i.e.:

- Recommended accuracy for high-precision thermometer in the range between 36°C and 39°C: +/- 0.2°C
- Recommended accuracy for CO₂ gas analyser in the range between 3% and 8% or between 3% and 12% (see section 10): +/- 0.3%
- Recommended accuracy for O₂ gas analyser in the range between 4% and 8%: +/- 0.5%.

13 Planned service and maintenance

13.1 Planned service

A person certified by Vitrolife will inspect and replace all of the following items in accordance with the intervals specified in the below table, except for the VOC HEPA filter, which may also be changed by clinic personnel:

Replaceable item	Description	Service interval (years)	Replaced by
VOC HEPA filter	VOC HEPA filter placed in the filter tray (under the service lid)	0.5	Certified service personnel or clinic personnel (outside service visits)
O ₂ sensor	1 x sensor placed on the gas circulation unit	3	Certified service personnel
UV light	Internal UV light placed in the gas circulation unit (UV light not connected in 100 V incubators)	1	Certified service personnel
Gas circulation fan	Fan placed inside the gas circulation unit	5	Certified service personnel
Proportional valves	Internal valves placed on the incubator adapter plate	6	Certified service personnel
12 V power supply unit	Internal 12 V power supply unit	5.5	Certified service personnel

It is recommended to schedule a service visit at least every 12 months in order to carry out planned service tasks. The clinic will be notified on the PC screen when it is time to schedule a service visit.

For further information on how to service the replaceable items, consult the manual entitled *Planned service and maintenance* (English only).

During each service visit, personnel certified by Vitrolife will also carry out routine calibration checks. These checks are not a substitute for the regular maintenance tasks performed by the clinic (see section 13.2).

13.2 Planned maintenance

In addition to the service tasks carried out by personnel certified by Vitrolife, it is the responsibility of the clinic to carry out the following maintenance tasks at regular intervals or as required:

- Validation and, if required, calibration of the internal sensors (see sections 4.1.4.2 and 4.1.5.3).
Frequency: Every two weeks.
- Cleaning and disinfection of the incubator (see sections 5.1 and 5.2).
Frequency: As required.
- Changing the VOC HEPA filter outside service visits (see section 6).
Frequency: Every six months.

13.2.1 Maintenance screen

On the **Maintenance** screen, you can generate a monthly incubation report, simulate an external alarm to ensure that the external alarm system works as intended and access the VOC HEPA filter and sensor validation settings.

To open the **Maintenance** screen, press the settings icon on the PC home screen and then press the **Maintenance** button.

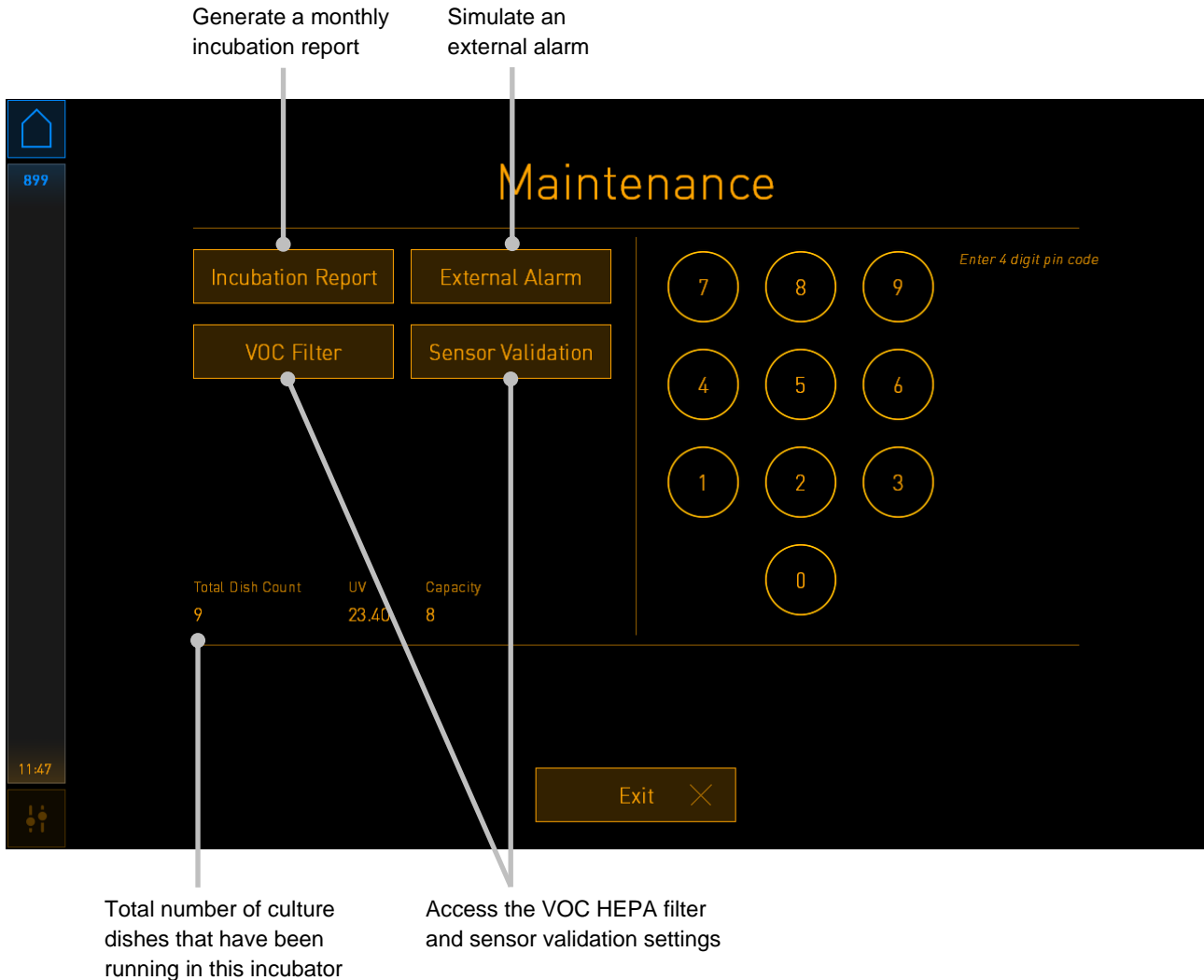

The pin code on the right side of the screen provides access to advanced maintenance functions to be carried out in collaboration with Vitrolife personnel. Vitrolife will issue a pin code if this is relevant.

Press the **Exit** button to exit maintenance mode and return to the **Settings** screen.

13.2.2 Generating a monthly incubation report

To generate a monthly incubation report, insert a clean USB stick into the USB port under the service lid at the top of the incubator, and press the **Incubation Report** button. The following screen is displayed:

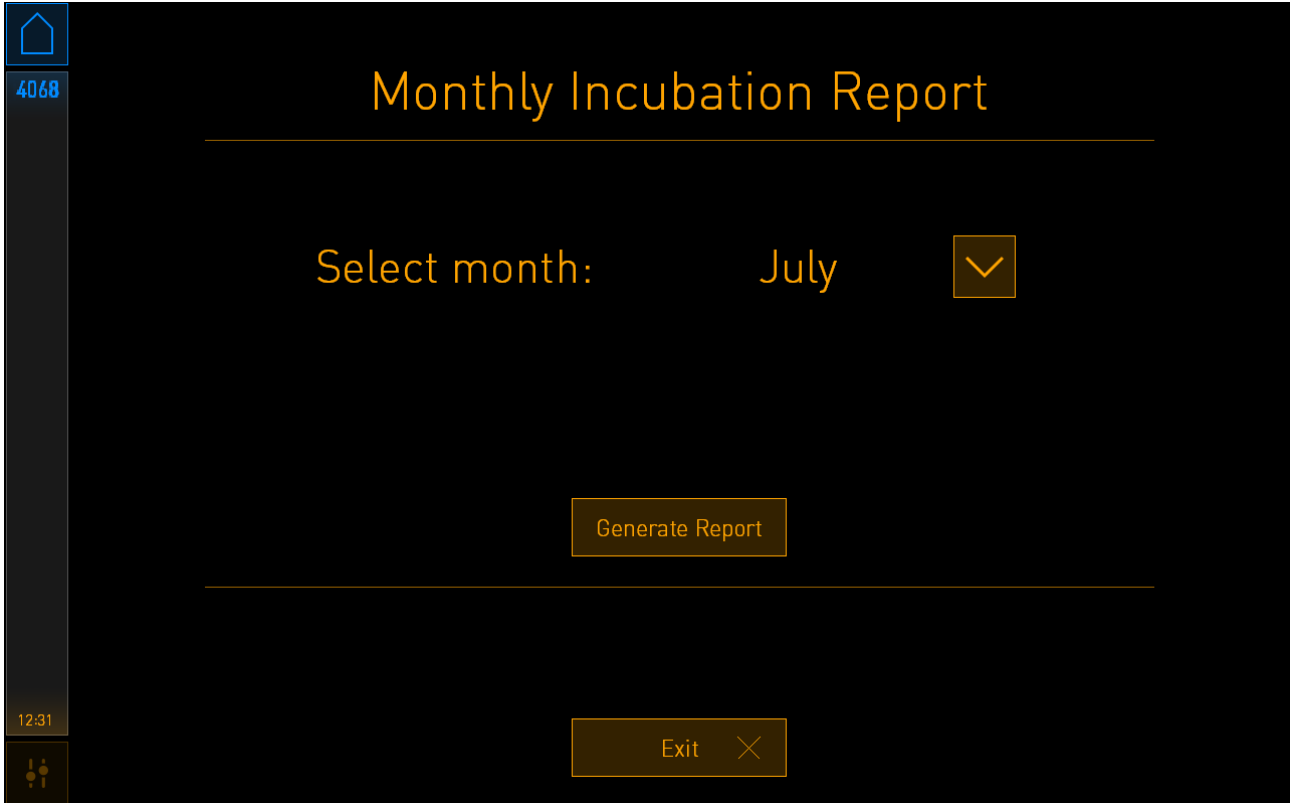

Select the month for which you want to generate an incubation report, and press the **Generate Report** button. A confirmation is shown when the report is ready. The data are saved on the incubator for 12 months, and you can thus generate reports for the last 12 months.

Press the **Exit** button to return to the **Maintenance** screen.

13.2.3 VOC HEPA filter and sensor maintenance

On the **VOC Filter and Sensor Maintenance** screen, the clinic can set reminders to change the VOC HEPA filter or to validate the internal sensors (temperature sensors A and B, the CO₂ sensor and, if the clinic incubates with reduced O₂ concentration, the O₂ sensor). These reminders are not enabled by default.

Open the **VOC Filter and Sensor Maintenance** screen by pressing either the **VOC Filter** button or the **Sensor Validation** button on the **Maintenance** screen (PC home screen -> **Settings** -> **Maintenance** button). Enable one or both options by pressing the corresponding radio button:

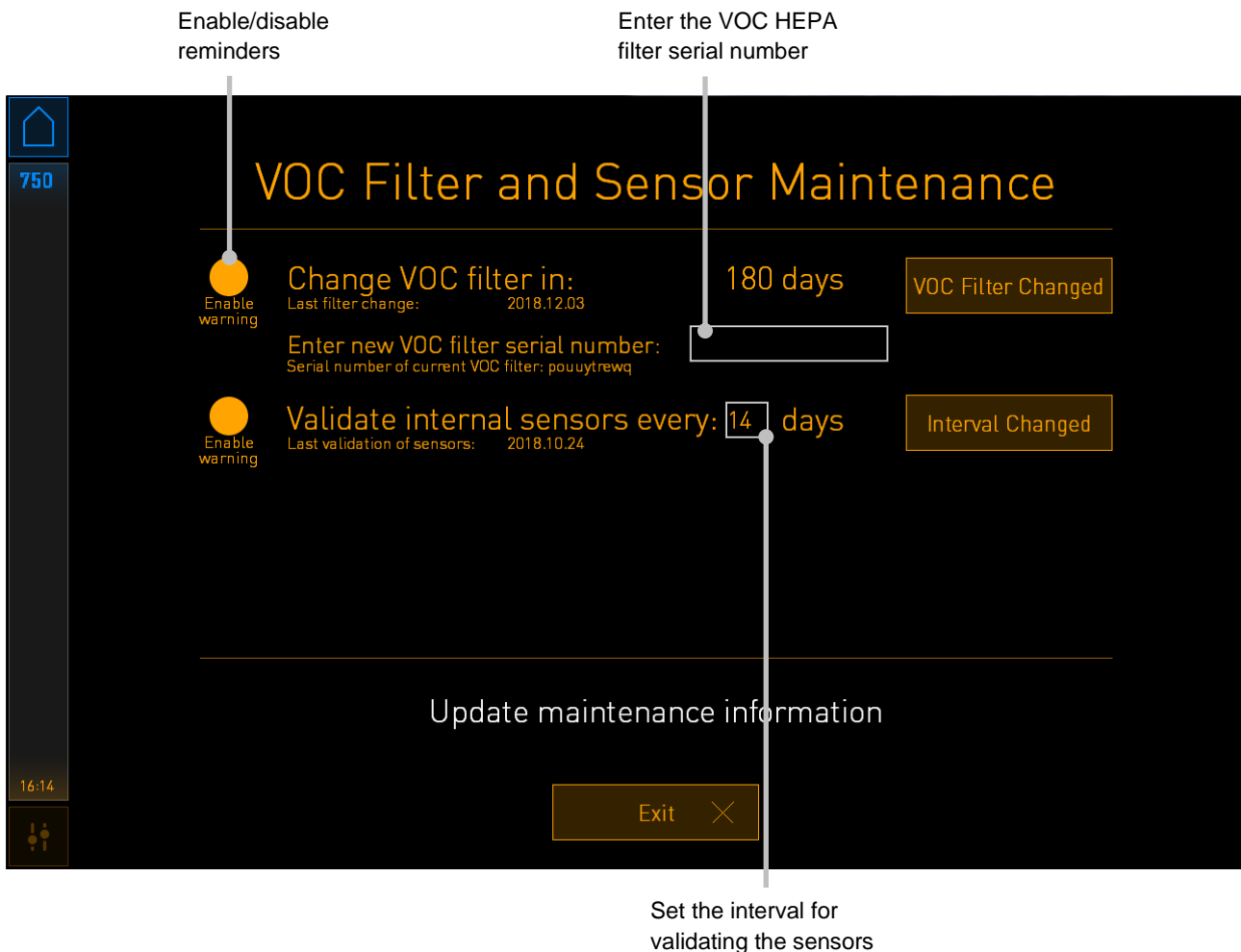

The interval for changing the VOC HEPA filter is 180 days. When the VOC HEPA filter is changed, you will be prompted to enter the serial number of the new VOC HEPA filter. Enter the serial number, and press the **VOC Filter Changed** button.

NOTE

- The 180-day period starts when you enable the VOC HEPA filter reminder and press the **VOC Filter Changed** button.

A warning will be shown on the PC home screen when it is time to change the VOC HEPA filter:

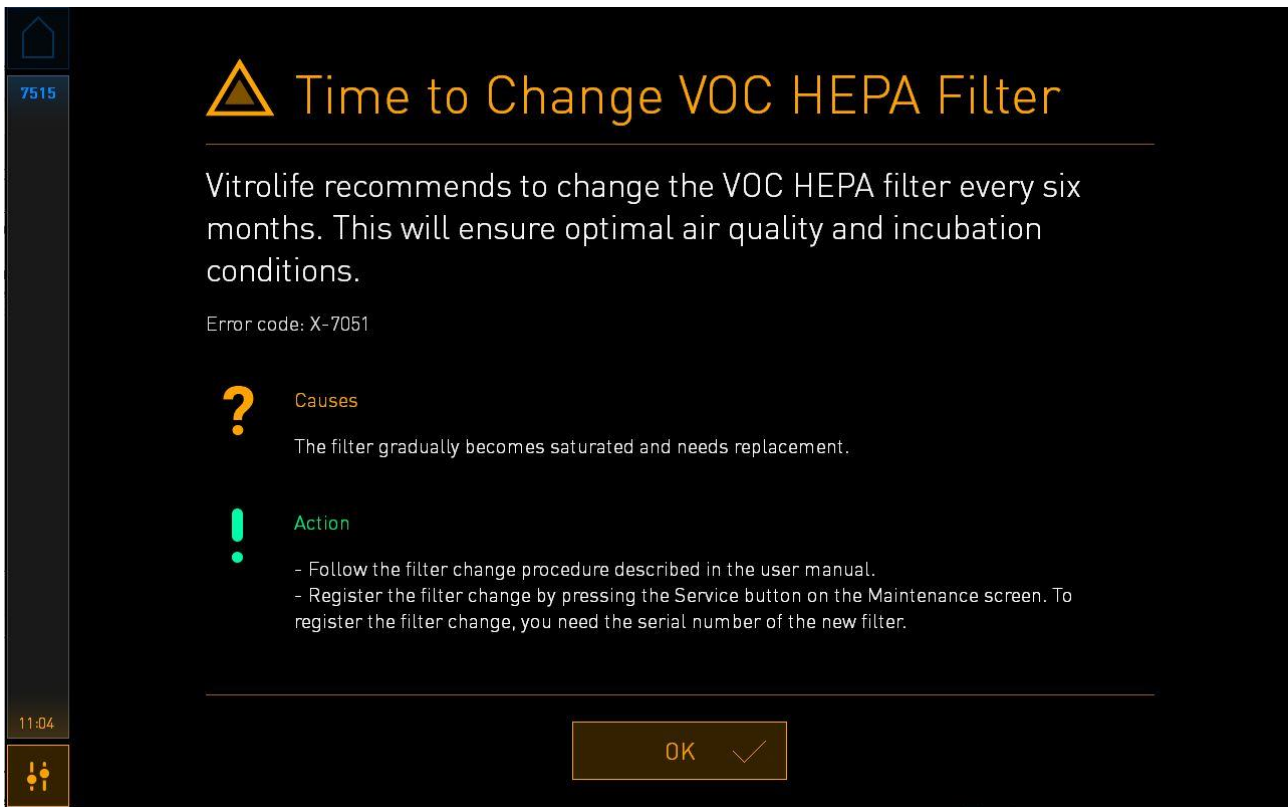

If you press **OK**, the warning will disappear and remain hidden for three days. If you do not change the VOC HEPA filter within this period, the warning will reappear. You can press **OK** as many times as you like, but the warning will reappear every three days until the filter is changed.

To clear the warning, change the VOC HEPA filter as described in section 6, and register the filter change as described under **Action** on the screen.

The default interval for validating the internal sensors is 14 days. This period can be changed by the clinic if required. Enter the new interval, and press the **Interval Changed** button.

A warning will be shown on the PC home screen when it is time to validate the internal sensors:

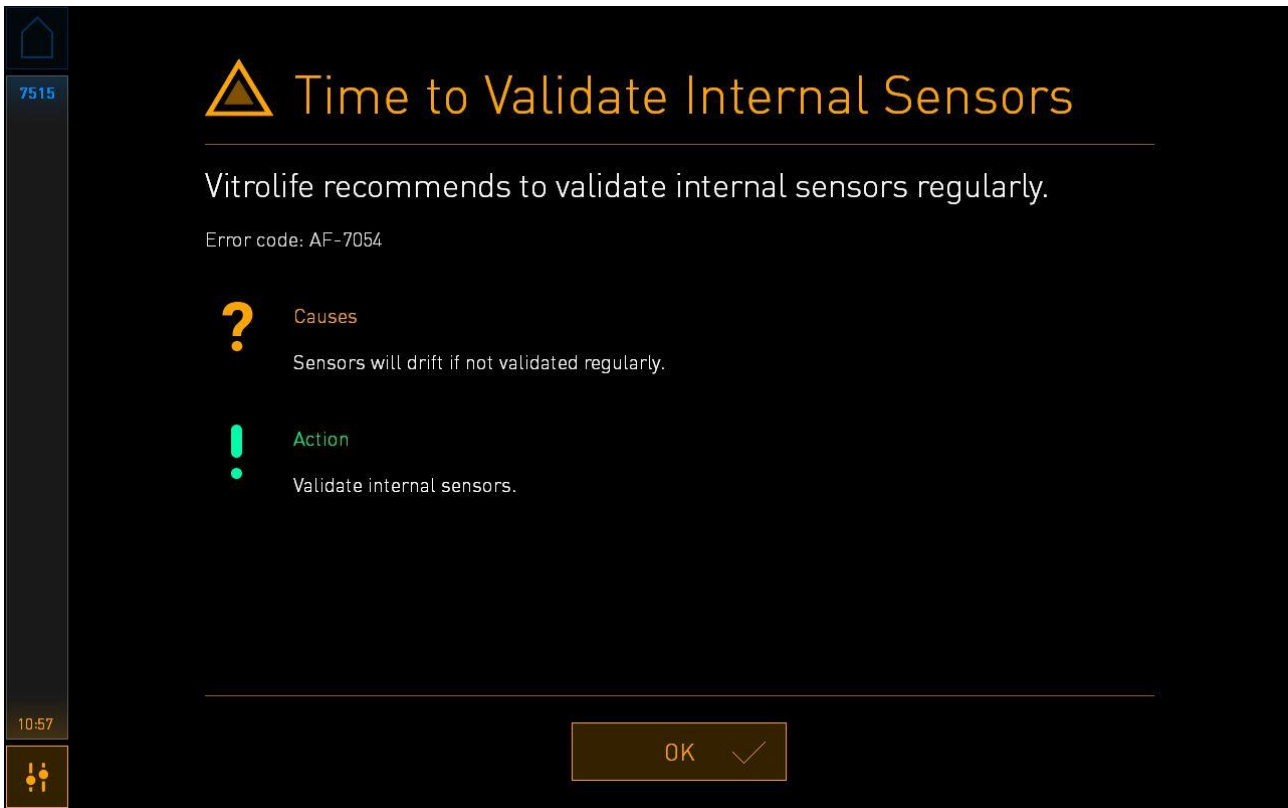









If you press **OK**, the warning will disappear and remain hidden for three days. If you do not validate the sensors within this period, the warning will reappear. You can press **OK** as many times as you like, but the warning will reappear every three days until the sensors are validated.





To clear the warning, validate and, if necessary, calibrate the sensors as described in sections 4.1.4.2 and 4.1.5.3.

Press the **Exit** button to exit maintenance mode and return to the **Settings** screen.

14 Symbols and labels

14.1 Product information labels





Label	Description	Note
	Model	See the front page of the user manual.
	Model reference number	-
	Type of power supply	See section 10.
	Declaration by the manufacturer that the device meets all of the applicable requirements in the Medical Device Regulation (EU) 2017/745	-
	Medical device	-
	Unique device identifier	-
	Maximum power consumption	See section 10.
	Manufacturer name and address	See section 16.
	Year and month of production	YYYY-MM

Label	Description	Note
	Country of origin	-
	Serial number	Model-version-production number
	Caution when discarded	See section 15.
	Refer to the user manual	-





14.2 Warning labels

Label	Description	Note
	Warns that the product is equipped with a UV light (not connected in 100 V incubators)	Placed in the gas system inside the incubator.

14.3 Connection labels

Label	Description	Note
	Gas sample pipe closed	Found under the gas sample cover at the front of the EmbryoScope 8 incubator.
	Gas sample pipe open	Found under the gas sample cover at the front of the EmbryoScope 8 incubator.
<p style="text-align: center;">Alarm</p>	External alarm output socket	See section 3.
<p style="text-align: center;">CO2 Inlet Pressure Max 1 Bar</p>	CO ₂ connection inlet	See section 3.
<p style="text-align: center;">N2 Inlet Pressure Max 1 Bar</p>	N ₂ connection inlet	See section 3.
	Ethernet connection socket	See section 3.
	USB connection socket	See section 3.
<p style="text-align: center;">Inc. data</p>	Connection for external logging system	See section 3.
<p style="text-align: center;">Replace with same type and rating 2 x T3, 15 A / 250 V</p>	Fuse replacement information	See section 10.

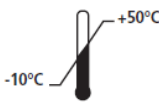
14.4 Labels on the shipping crate

Label	Description	Note
	Fragile	-
	This side up	-
 <p data-bbox="391 1008 486 1041">Keep dry</p>	Keep dry	-
 <p data-bbox="375 1198 502 1232">Temperature</p>	Storage temperature: Minimum: -10°C Maximum: 50°C	°C
	Humidity limitation: Minimum: 30% Maximum: 80%	%
	Atmospheric pressure limitation	kPa

15 Disposal of waste

In order to minimise the waste of electrical and electronic equipment, waste must be disposed in accordance with the Directive 2012/19/EU on waste electrical and electronic equipment (WEEE) as amended by Directive (EU) 2018/849. This includes: PCBs (lead-free HASL), switches, PC batteries, printed circuit boards and external electrical cables. All components are in accordance with the RoHS 2 Directive 2011/65/EU, which states that new electrical and electronic components do not contain lead, mercury, cadmium, hexavalent chromium, polybrominated biphenyls (PBB) or polybrominated diphenyl ethers.

It should, however, be noted that the UV lamp (which may or may not be active in your specific product) contains toxic compounds, irrespective of its physical condition. This is in accordance with the provisions of the RoHS Directive mentioned above.

Taking into account the toxic content, the UV lamp should be disposed of according to local waste management requirements and environmental legislation. It should not be burned since it may evolve toxic fumes.

16 Contact information

Urgently need help? Call our service hotline for support:

+45 7023 0500

(available 24 hours a day, 7 days a week)

E-mail support: support.embryoscope@vitrolife.com

(response within two working days)



Vitrolife A/S
Jens Juuls Vej 16
DK-8260 Viby J
Denmark

Telephone: +45 7221 7900

Website: www.vitrolife.com

Vitrolife 

VITROLIFE A/S, DENMARK